

POGO[®] CONTACT SOLUTIONS



ICT/FCT

GENERAL PURPOSE

HIGH CURRENT

HIGH FREQUENCY

SWITCH PROBE

STEP PROBE

BATTERY CONTACT

SEMICONDUCTOR

Quick Reference

A-A-S	73	LFRE-72	22
A-S	73	LTP-1	35
BIP 1-12	101-102	LTP-25	36
BMP 1-3	46	LTP-72	34
BMP-4	47	MEP-20	78
BMP-5	48	MEP-22B	72
BPLT-1	40	MEP-30	50
BPLT-25	41	MEPJ-21	78
BTM	112	MEPJ-22BD	72
BTP-1	38	MSP-25C	93
BTP-25	39	MSP-3C	93
BTP-72	37	MSP-5C	95
CCA-003-006	103	MTX-39	16
CP-059	104	MTX-50	17
CP-2	105	MXLT-39	18
CP-4	106	MXLT-50	19
C-S	74	P2447-1W	82
CSP-30	86-87	P2532	76
CSP-40	88-89	P2550	76
CSP-03	87	P2662 A/B	52
CSP1	116	P2663	57
CSP4	113	P2664	60
CSP5	114	P2665	64
CSP8	115	P2757	67
DER	45	P3158	61
EPA-2	59	P3325	82
EPA-3	65	P4301	83
EPA-4	66	P5160	62
EPA-5	68	POGO-1	28
E-S	74	POGO-25	29
FRP-25T	43	POGO-25HM-4	43
F-S	75	POGO-25T-4	43
GPP-95	44	POGO-62	26
G-S	75	POGO-72	27
GSP-2B	42	PP-3070	42
GSP-2BL	42	RMP-22B	50
HC-375	84	RSP-2T	43
HC-500	84	SCP	117
HCP-13	80	SIP-90	44
HCP-14	81	SPA-0	54
HCP-15	81	SPA-1	55
HCP-25	80	SPA-2	59
HPA-0	54	SPA-3	65
HPA-1	55	SPA-4	66
HPA-40	51	SPA-5	68
HPA-50	53	SPA-64	63
HPA-52	56	SPL-03	99
HPA-64	63	SPL-03C-069	94
HPA-74	58	SPP-25	69
K-50B-S, H-S	89	SSP-5C	94
K-50B, L	90-91	STP-1	97
LFLT-1	31	STP-25	98
LFLT-25	32	Z0	108
LFLT-72	30	Z-040	109
LFRE-1	23	Z-050	110
LFRE-25	24	Z - Kelvin	111
LFRE-39	21		

Table of Contents

About us	4
Information	5
Tip Style Overview	8
Receptacle	11

ICT / FCT	
MTX-39	16
MTX-50	17
MXLT-39	18
MXLT-50	19
LFRE-39	21
LFRE-72	22
LFRE-1	23
LFRE-25	24
POGO-62	26
POGO-72	27
POGO-1	28
POGO-25	29
LFLT-72	30
LFLT-1	31
LFLT-25	32
LTP-72	34
LTP-1	35
LTP-25	36
BTP-72	37
BTP-1	38
BTP-25	39
BPLT-1	40
BPLT-25	41
GSP-2B	42
GSP-2BL	42
PP-3070	42
RSP-2T	43
FRP-25T	43
POGO-25HM-4	43
POGO-25T-4	43
SIP-90	44
GPP-95	44
DER	45
BMP1-3	46
BMP-4	47
BMP-5	48

Pylon®

Only Pylon Products

A-A-S	73
A-S	73
C-S	74
EPA-4/SPA-4	66
E-S	74
F-S	75
G-S	75
HC375	84
HC500	84
P2447-1W	82
P2532	76
P2550	76
P2662 A/B	52
P2663	57
P2664	60
P2665	64
P2757	67
P3158	61
P3325	82
P4301	83
P5160	62

GENERAL PURPOSE

RMP-22B	50
MEP-30	50
HPA-40	51
P2662A	52
P2662B	52
HPA-50	53
HPA-0 / SPA-0	54
HPA-1 / SPA-1	55
HPA-52	56
P2663	57
HPA-74	58
EPA-2 / SPA-2	59
P2664	60
P3158	61
P5160	62
HPA-64 / SPA-64	63
P2665	64
EPA-3 / SPA-3	65
EPA-4 / SPA-4	66
P2757	67
EPA-5 / SPA-5	68
SPP-25	69
MEP-22B	72
MEPJ-22BD	72
A-A-S	73
A-S	73
C-S	74
E-S	74
F-S	75
G-S	75
P2532	76
P2550	76
MEPJ-21	78
MEP-20	78

HIGH CURRENT PROBE

HCP-25	80
HCP-13	80
HCP-14	81
HCP-15	81
P3325	82
P2447-1W	82
P4301	83
HC375	84
HC500	84

HIGH FREQUENCY PROBE

CSP-30ES-013	86
CSP-30TS-011	87
CSP-03B-006	87
CSP-03G-003	87
CSP-40B-012	88
CSP-40L-013	88
CSP-40A-015	89
CSP-40A-024	89
CSP-40G-021	89
K-50B-S	89
K-50H-S	89
K-50L	90
K-50L-QG	90
K-50L-QG-75	91
K-50L-QG-75R	91

SWITCH PROBE

MSP-25C	93
MSP-3C	93
SPL-03C-069	94
SSP-5C	94
MSP-5C	95

STEP PROBE

STP-1	97
STP-25	98
SPL-03	99

BATTERY PROBE

BIP-1	101
BIP-2	101
BIP-3	101
BIP-8	101
BIP-10	102
BIP-12	102
CCA-003	103
CCA-004	103
CCA-006	103
CP-059-019	104
CP-059-025	104
CP-059-026	104
CP-2	105
CP-4	106

SEMICONDUCTOR PROBE

Z0	108
Z-040	109
Z-050	110
Z - Kelvin	111
BTM	112
CSP4	113
CSP5	114
CSP8	115
CSP1	116
SCP	117

Tools and Maintenance	118
Compliant Connector Solutions	121
How to Order	122



Since its founding in 1965, Everett Charles Technologies has been the leader in developing innovative and cost-effective solutions for all electronic interconnect and test markets. New and emerging technologies in networking, mobile devices, medical, automotive and industrial products elevate every aspect of our lives and they require contact solutions of unprecedented quality, miniaturization and integrity to interconnect and test reliably and cost-effectively. Everett Charles Technologies has been at the forefront of product development and quality to meet these requirements with premier products which involve more than and over 100 patents beginning with its invention of the first replaceable spring probe whose descendants still set the standard in compliant contact technology today. As you embark on future product developments, know that we are ready to partner with you to define all of your Contact Solutions.



Visit the below link to download the valid certificates:

www.ect-cpg.com/compliance-statements



In 1879, when Ostby Barton opened its doors for business, the company's inventive minds were opening doors to new technologies and exploring revolutionary concepts that today we take for granted. This inventive spirit was the driving force behind an important series of events. The company's manufacturing and engineering expertise expanded rapidly, and after achieving a leading position in jewelry manufacturing, Ostby Barton refocused its efforts in 1948 to become a custom manufacturer of precision electro-mechanical contacts. In 1986 the company joined the Everett Charles family. Today the Ostby Barton Division of Everett Charles Technologies is a leader in the design and fabrication of standard and custom spring loaded test probes – products supported by years of experience and innovation unmatched in the industry. Ostby Barton contact probes are designed, supported, and marketed throughout the world from the group headquarters in Warwick, Rhode Island on the east coast of the USA.



Fontana, CA (USA)



Warwick, RI (USA)



Rosenheim (Germany)



THE ECT DIFFERENCE

ECT invented the snap-out probe in 1965. It was the first replaceable spring probe available to test engineers when ATE was in its infancy. The hand-assembled probe was simple and rugged. Modern spring probes retain some fundamental attributes of the original design, but they are far more sophisticated. Mechanical design evolves on CAE/CAD systems, enabling our engineers to program manufacturing equipment to optimize their designs. Custom designed machining equipment, plating processes, and automatic assembly systems produce precision probes with ultra-smooth surfaces. Plunger-to-barrel tolerances are tighter. Probe tips are sharper. Springs fabricated from specially-formulated alloys maximize probe life. Quality checks are made throughout the manufacturing process using computerized statistical process controls. Final inspection ensures that the probes we ship are defect-free.



ECT CUSTOM PROBE SOLUTIONS

If our standard products don't meet your requirements, Everett Charles Technologies will design and manufacture a custom spring probe to meet your needs. With over 50 years' experience in manufacturing spring probes, ECT's know-how and customer commitment can be trusted to provide an on-target solution.

Contact us to discuss the limitless possibilities.



ECT MANUFACTURING

ECT is proud to produce many probe components in-house. This enables us to have full control of our quality standards and allows us to react quickly to customer demands.

The assembly process is typically automated, semi-automated, or done by hand, depending on probe complexity and volume.



ELECTRICAL CURRENT PATH

The primary current path in a probe is through the contact junction of the plunger with the barrel and the barrel with the receptacle. Secondary paths include the contact junction between the spring and plunger and the spring and barrel.

ELECTRICAL PROBE RESISTANCE

Resistance is dependent on several factors: conductivity of base metals and plating material, resistance at points of contact between components (which is affected by surface condition), area of contact, force applied at contact junctions, and probe design. For applications requiring very low and consistent resistance, such as loaded-board test, ECT's PogoPlus® probes feature an enhanced bias ball design that maintains electrical contact between the plunger and the sidewall at all times. ECT probes are self-biasing, resulting in maximum metal-to-metal contact between components at critical contact junctions. Electrical resistance is included among probe specifications on each data page.

TRAVEL

Most probes are rated with a working travel and a full travel position. Full travel is the maximum travel the probe is able to make, before either the plunger recessed into the barrel or the spring bottoms out at full deflection and becomes solid. Full travel causes springs to wear more quickly; therefore we specify a working travel position which is typical 2/3 of the full travel position. This will prevent the probe from bottoming out and extend the life of the spring.

FORCE

Force values are provided throughout this catalog in both "oz. and (grams)". Conversion from ounce-force to gram-force: 1.00 oz = 28.35 grams. Conversion from ounce-force to newtons: 1.00 oz = 0.28 newtons.

PLUNGER

Plungers are generally manufactured from BeCu (Beryllium Copper), then heat-treated and plated with gold or other plating materials. Some tip styles requiring extended tip life, are made from stainless steel, then heat-treated and plated.

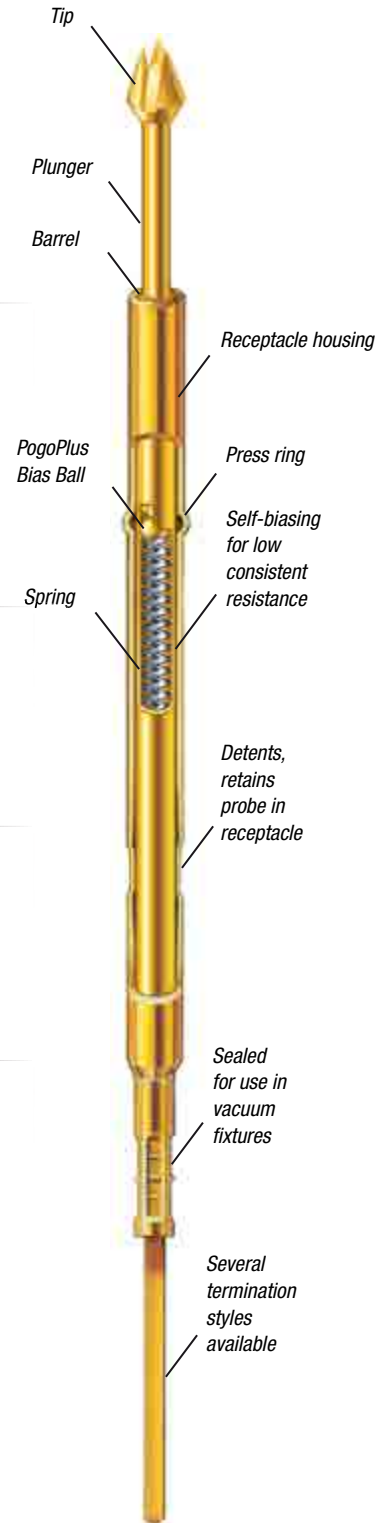



SPRING

The spring provides the required compliant force at the plunger tip, and the contact force between the barrel and the plunger. Several spring materials are offered, depending on probe size, spring force and application requirement. Spring material may also be plated with precious metals to improve electrical performance and prevent corrosion.

Higher spring forces will provide you with a more effective penetration through contamination contact points, but also leaving heavier witness marks on the test point. Lower spring forces might be used where witness marks must be avoided or to prevent board flexing on higher pin count applications.

Typical spring force tolerance is $\pm 20\%$. A tighter tolerance range can be achieved if required.

- **BeCu** is the weakest of the spring materials. However due to its electrical performance, it is used on low-resistance applications.
- **Music Wire** is a high carbon steel wire chosen for its consistency and strength.
- **Stainless Steel** is very strong and typically used on high temperature applications or in corrosive environments.

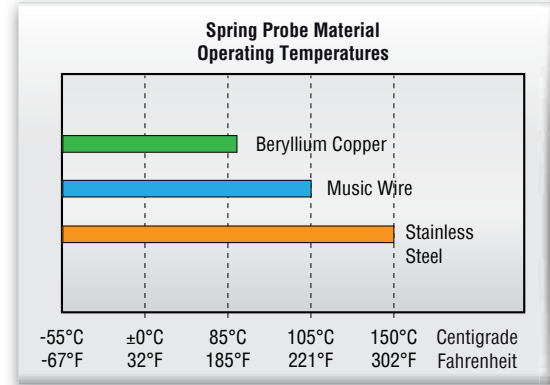

BASE MATERIALS

- **BeCu** is used because it is an excellent electrical conductor and is easily machined and hardened.
- **Stainless Steel** provides a much harder base material and is mainly used on medium to aggressive tips styles to provide longer lifetime.
- **Phosphor Bronze** is a choice for barrel material due to its excellent wear property.
- **Brass** is a very good electrical conductor, easy to machine and will accept all plating types.
- **Nickel Silver** is a good electrical conductor and provides excellent dimensional repeatability.
- **HyperCore™** is a new base material which provides longer life and does not require plating. Only used on Semiconductor probes.





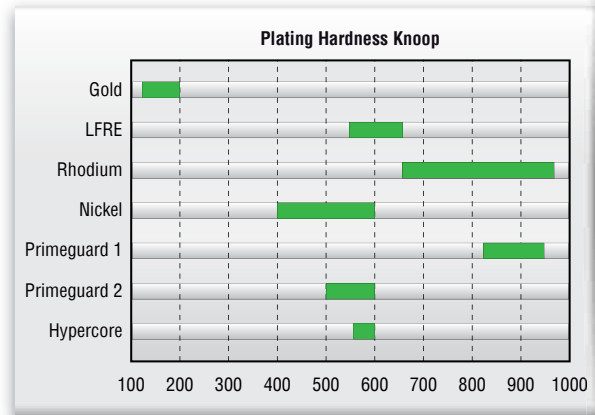





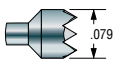



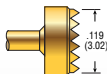

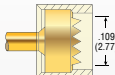





PLATING

- **Gold** provides excellent electrical performance for low-resistance applications.
- **LFRE** is a proprietary hard plating alloy. Used on lead-free (RoHS) PCB boards and contact points. Approx. 5 times harder than gold plating to extend tip lifetime. Less prone for solder transfer on 100% tin applications.
- **Rhodium** is very hard corrosion resistant, and typical preferred when maximum tip life is preferred.
- **Nickel** provides relatively hard plating and is used mainly on probes for its very good chemical resistance.
- **Primeguard** is a very hard plating option only used on Semiconductor probes to extend life and cleaning cycles on 100% tin or palladium based applications.
- **HyperCore™** is a new base material which provides longer life and does not require plating. Only used on Semiconductor probes.



























TIP GEOMETRY

Everett Charles Technologies, Ostby Barton, and Pylon offer a large variety of different tip geometries. Here are a list of tip geometries that you will find throughout the catalog on various probe series. Most tips are shown with gold plating, however on several probe series the same tip styles are available with different plating material.

Tip Style		Tip Style		
	A Pylon: V	Cup Headed concave 90°/120°		H-79 Serrated Headed multiple Point waffle
	B Pylon: C	Point Straight Shaft Spear 30°/34°/60°/90°/120°		H-INS Insulated Headed serrated with isolating ring
	C... Pylon: F	Flat Straight Shaft Flat		HM Serrated Oversized multiple Point waffle
	C30	Flat Reduced Flat		HM-INS Insulated Oversized serrated with isolating ring
	D Pylon: 2R	Radius Headed Bullet Nose		I... Blade Straight Shaft Lance 90°
	E Pylon: P	Conical Headed Convex 90°/106°		I15 Blade Straight Shaft Lance 155°
	F	Flat Headed Flat		I35 Blade Straight Shaft Lance 35°
	FP	Flat Star Straight Shaft 6 Point Star		I40 Blade Straight Shaft Lance with facet 40°
	G...	Cup Straight Shaft concave		J Pylon: R Radius Straight Shaft Bullet Nose
	G12	Cup Reduced concave		J40 Pylon: R Radius Straight Shaft Bullet Nose, Ø.040
	G30	Cup Reduced concave		J30 Pylon: J Radius Reduced Bullet Nose, Ø.030
	H Pylon: W	Serrated Headed multiple Point waffle		L Pylon: Q Crown Headed 4-Point Crown



Tip Style		Tip Style	
	L18 Crown Reduced 4-Point Crown		T67 Pyramid Headed 3-Sided Chisel 30°
	L24 Crown Straight Shaft 4-Point Crown		T79 Pyramid Headed Shaft 3-Sided Chisel
	L36 Pylon: Q Straight Shaft 4-Point Crown		TJ Test Jet Special tip for Open Test Product Probes
	P Star Headed 6-Sided hexagon Star		U Crown Reduced 3-Point Crown
	T Pyramid Headed 3-Sided Chisel 30°		UN Trident Headed 3-Spike Triad
	T1 Pyramid Reduced 3-Sided Chisel 10°		V Tulip Headed 7-Point Crown
	T10 Pyramid Straight Shaft 3-Sided Chisel 10°/15°		X Tapered Crown Headed 4-Point Crown
	T20 Pyramid Straight Shaft 3-Sided Chisel 30°		Z Crown Oversized 8-Point Crown
	T24 Pyramid Straight Shaft 3-Sided Chisel 10°/15°		Z1 Crown Headed 8-Point Crown
	T30 Pyramid Straight Shaft 3-Sided Chisel 30°		HC Serrated Straight Shaft microstructured Bead
	T36 Pyramid Straight Shaft 3-Sided Chisel 10°/15°		HF Serrated Headed microstructured Bead
	T38 Pyramid Headed 3-Sided Chisel 30°		HL Serrated Oversized microstructured Bead

TIP SELECTION

Most tip styles can be used for a variety of different applications. Use the following chart to select appropriate tips for the feature type (pad, via, etc.) you are testing. Several tip styles will probably work for a given application, so experiment with several tips until you find one that provides the best performance. For testing loaded boards, tip selection factors to consider are lead length (bent or straight), surface cleanliness, and pad size. In general, tips with sharp points and internal cutting edges which trap leads (such as the Trident or crown tip) are excellent choices for most loaded board requirements. In bare board applications, tips with sharp external cutting edges (such as fluted and pyramid tips) are usually best for penetrating through contamination, but these may leave marks on the contact surface. For applications where marking is undesirable, bullet nose or conical tips may be used on clean boards.

Tip selection is crucial when selecting a probe, so please feel free to contact your nearest ECT facility. We are more than happy to assist you with your tip selection.

Pads

Some applications require a non aggressive tip like the D,J or F type tip. These tips leave no marks or footprints on the test pads. Other applications may need to break through oxide layers, OSP or other contaminations. For these test points the B,E,I,L,T and U Tip with their medium to very aggressive geometry penetrate through the contaminations and offer best first pass contact.

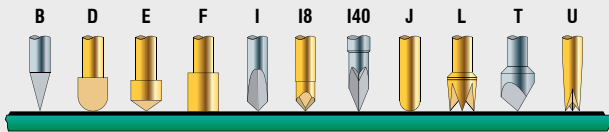

Solder Pads, Solder Balls

Over time solder build up oxide layers, therefore medium to very aggressive tip geometries are used. H-INS or HM-INS Tip – The tip geometry is designed with a pin present detection. If a component lead is not soldered correctly and fully into the PCB board, the insulating ring around the H tip will act as a collar, preventing the conductive probe tip from making contact with the faulty test point.

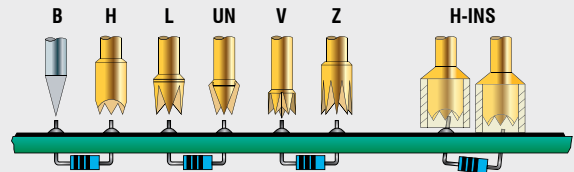

Vias

Typical tips are used that center themselves into the via hole. ECT offers a variety of different I tip angles, which are used to accommodate through-hole vias as well as solder filled holes. Other Tips like the G or V tip are suited to contact only the outer ring of the vias on the board surface.

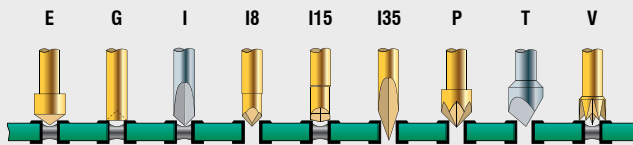

Posts, Pins and Screws

For other applications like posts, pins or screws are more unpredictable and therefore more challenging to select the best tip style. Posts and pins are captured with tips like the A, H or L Tip. Other applications depending on material, size, shape, access or clearance, contamination and so on may require other tips.

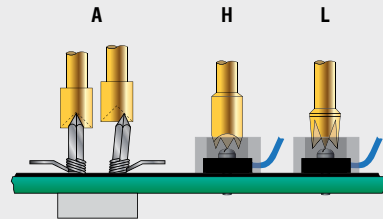

TERMINATION TYPES

Several receptacle termination styles are available to choose from as listed on this page. Some styles are only available in certain sizes; please see the specific probe series page for details. Within the tool section you will find insertion and extraction tools offered by ECT as well as installation tips for receptacles.



CRIMP

This reliable connection is used primarily on smaller probe sizes in high density applications where wire wrap is not available or in situations where probe plate thickness inhibits the use of wire wrapping. Push-on terminals can also be used and are commercially available from most connector manufacturers.



SOLDER

This termination provides excellent electrical integrity for high reliability applications. It is used primarily in low density situations.



WIRE WRAP

These terminations are strong and provide excellent electrical integrity. It is the most common termination used in ATE fixturing. Connections can be made quickly by skilled technicians. Push-on terminals which fit the standard .025" (0.64 mm) square post can also be used.



ROUND POST

Round Post receptacles with .025" (0.64 mm) diameter posts are used with .100" (2.54 mm) center connectors and/or ribbon cable assemblies for mass termination.



FASTITE®

Fastite® or Quick Connect™ termination provides exceptional contact integrity and is available only on SMT receptacles. Connections can be made quickly and wiring mistakes can be corrected easily without damaging the receptacles.

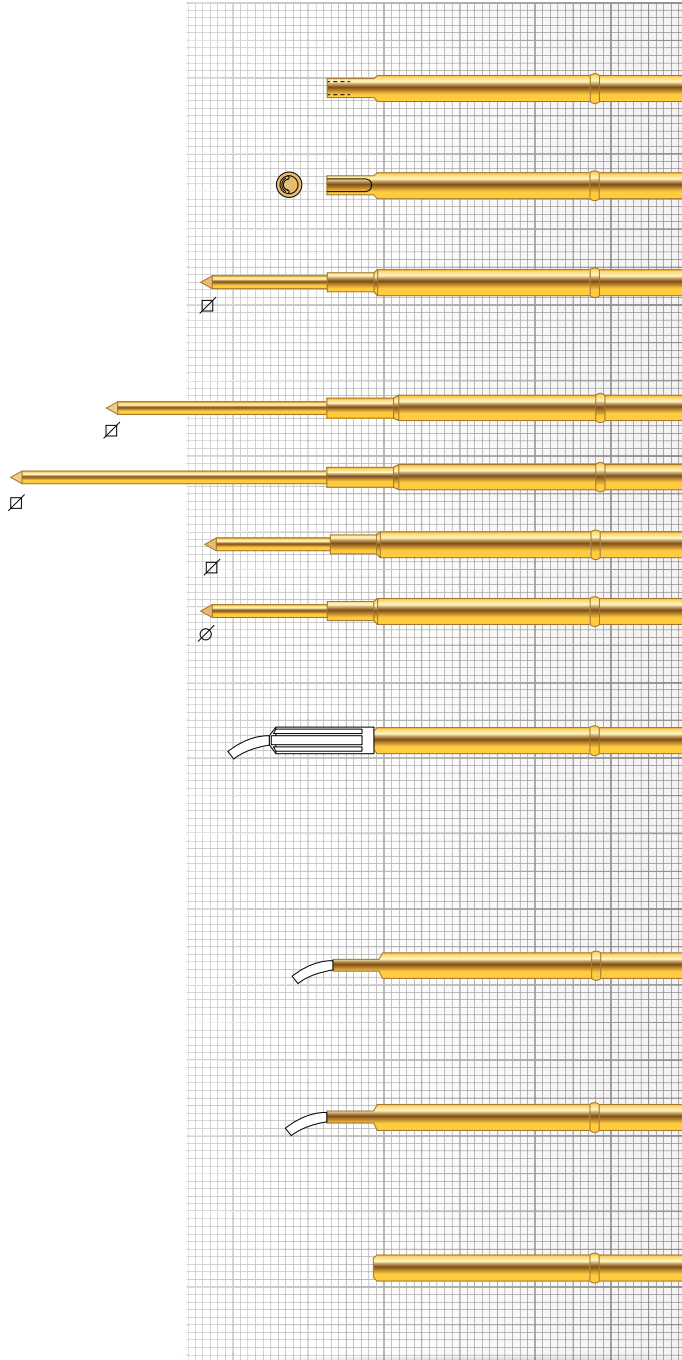

W Crimp

Typically used to attach a wire by mechanical crimping

W-1 Solder Cup

Typically used to attach a wire by soldering

W-2 Wire Wrap Post

Square post \varnothing .025 (0.64)

Vacuum leak rate not to exceed 1×10^{-4} CFM@15psi

W-2L Wire Wrap Post - long

W-2LL Wire Wrap Post - extra long

W-2M Wire Wrap Post - short

W-3 Connector Pin/Round Post

Round post \varnothing .025 (0.64)

Vacuum leak rate not to exceed 1×10^{-4} CFM@15psi

W-4 Fastite®

Wire termination (30 AWG only)

Maximum wire insulation diameter = .019 (0.48)

Wire strip length = .125 (3.20)

DS-62-1 Insulation sleeve is included

Recommended maximum current 1.0A DC

Maximum temperature may not exceed 105°

W-28 Prewired

Crimp with 30" of 28 AWG wire attached

Maximum temperature not to exceed 105°C

Recommended maximum current 1.5A DC

W-30 Prewired

Crimp with 30" of 30 AWG wire attached

Maximum temperature not to exceed 105°C

Recommended maximum current 1.0A DC

Y Push on

Push on termination

OB - Pylon

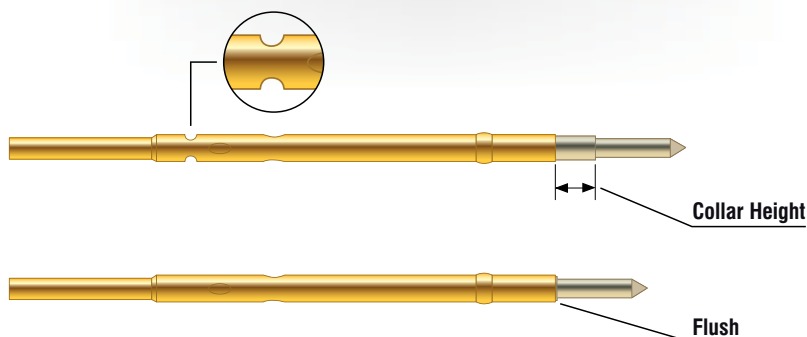
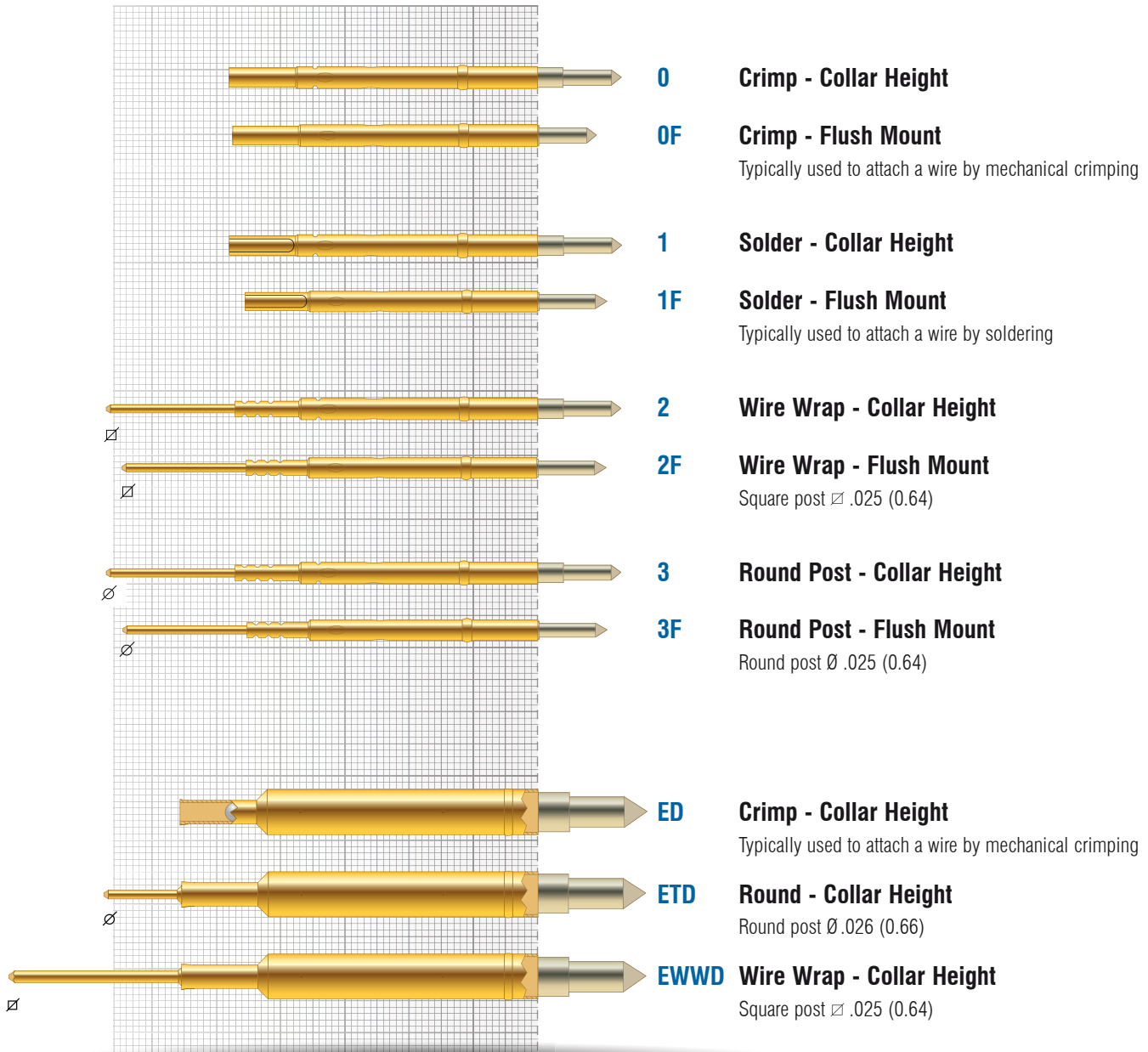

COLLAR HEIGHT

Most of the Ostby Barton / Pylon receptacle series offer a collar height option. A collar will raise the probe out of the receptacle by the mentioned height as shown in the illustration.



Probe Advantage

POGOPLUS® SERIES PROBES

Conventional bias-type probes are susceptible to false opens — that is, transient electrical discontinuities that cause good products to “fail” during test. Revolutionary PogoPlus probes eliminate probe-induced false opens, saving you the time, money, and needless product retesting.

The unrivaled electrical performance of the PogoPlus is due to the interaction between the spring, captured ball, and plunger, which forces the plunger into continuous contact with the barrel wall at all times. The result is uninterrupted electrical continuity and low overall resistance that can't be equaled by any other “high performance” probe.

The PogoPlus® is also designed to be the world's most durable probe with features like optional stainless-steel MicroSharp™ tips, a larger spring volume, and enhanced pointing precision.

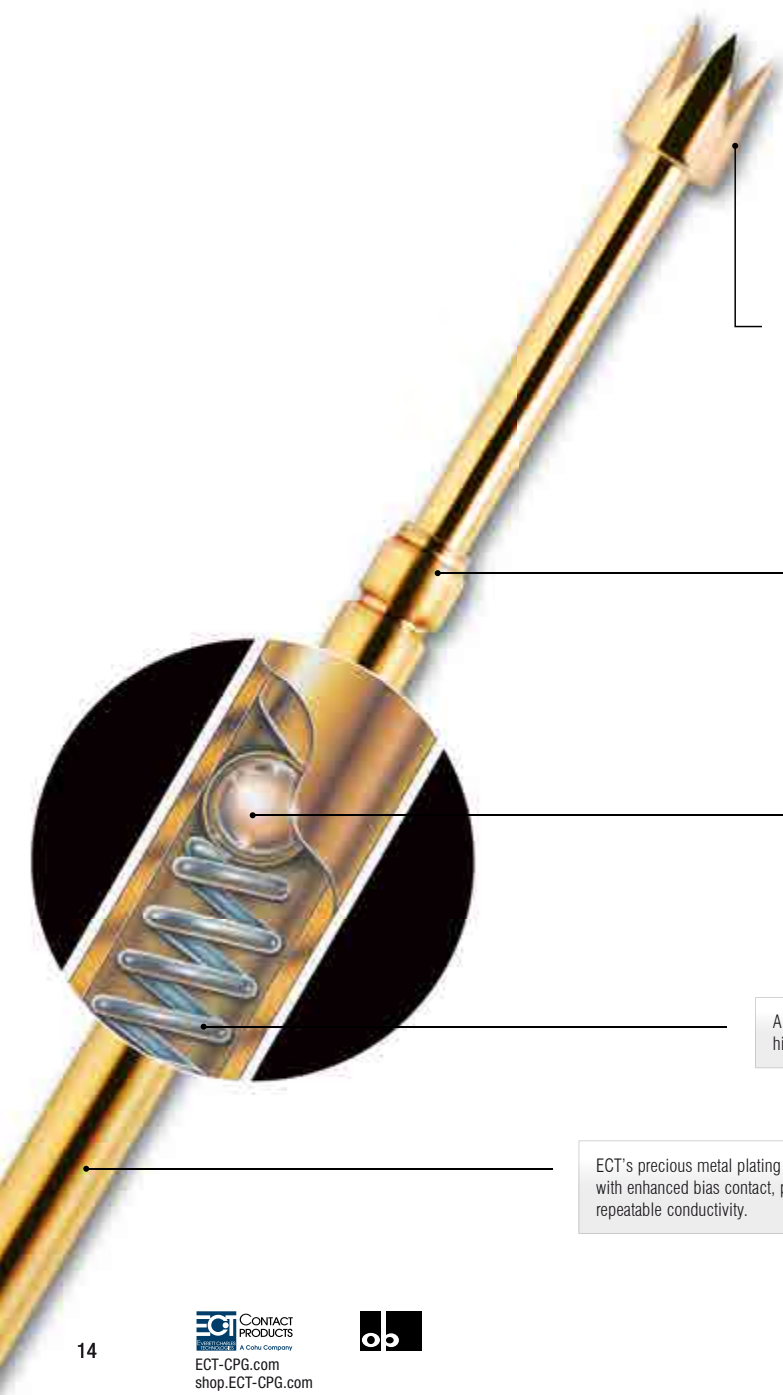

Available steel tips, manufactured with ECT's MicroSharp™ technology, offer the ultimate in long-lasting tip sharpness and contact integrity. A variety of innovative tip styles give you the flexibility to match the PogoPlus® to your specific test application.

A double-roll close offers the industry's best pointing accuracy that helps you hit the smallest test targets with high repeatability.

Interaction of the captured ball, bias-cut plunger end and applied spring force guarantees uninterrupted electrical contact with the probe barrel sidewall, virtually eliminating probe related false opens.

A shorter plunger permits more spring volume, higher spring force and longer spring life.

ECT's precious metal plating process, together with enhanced bias contact, provides highly repeatable conductivity.

LOADED PCB TEST PROBES / FUNCTIONAL

The ICT / FCT product lines, which include the LFRE and PogoPlus® Series, address the unique demands of loaded board and vacuum fixture applications. Most probes feature an enhanced version of the legendary bias-ball design to virtually eliminate “false opens”, proprietary metal plating processes for higher conductivity, and precision MicroSharp™ steel tips for long-lasting durability. A full range of sizes accommodates applications with mixed test center requirements.

Mixed Test Centers

In loaded board applications, probes are designed for use on 0.039, 0.050, 0.075 and 0.100 inch test centers. They can also be mixed in single or dual-stage fixtures, even those with minor variations in plunger travel. When mounted correctly, probe plunger tips will align when compressed to recommended working travel. This ensures contact integrity between the tip and test pad. Minor adjustments may be required to compensate for variations in accessing component leads, flat test pads, or through-holes.



**Pogo
Plus**

Metrix™

- **LFRE:** The solution for your RoHS complaint boards and lead-free solder test points.
- **POGO:** High performance ICT / FCT probes similar to the LFRE probe, but with gold plated tips. Features the legendary PogoPlus® Bias Ball design.
- **METRIX:** Probe series for smallest test centers down to .039 inch or 1.00 mm.
- **LTP/LFLT:** High performance ICT/FCT long probes for dual-stage fixtures.

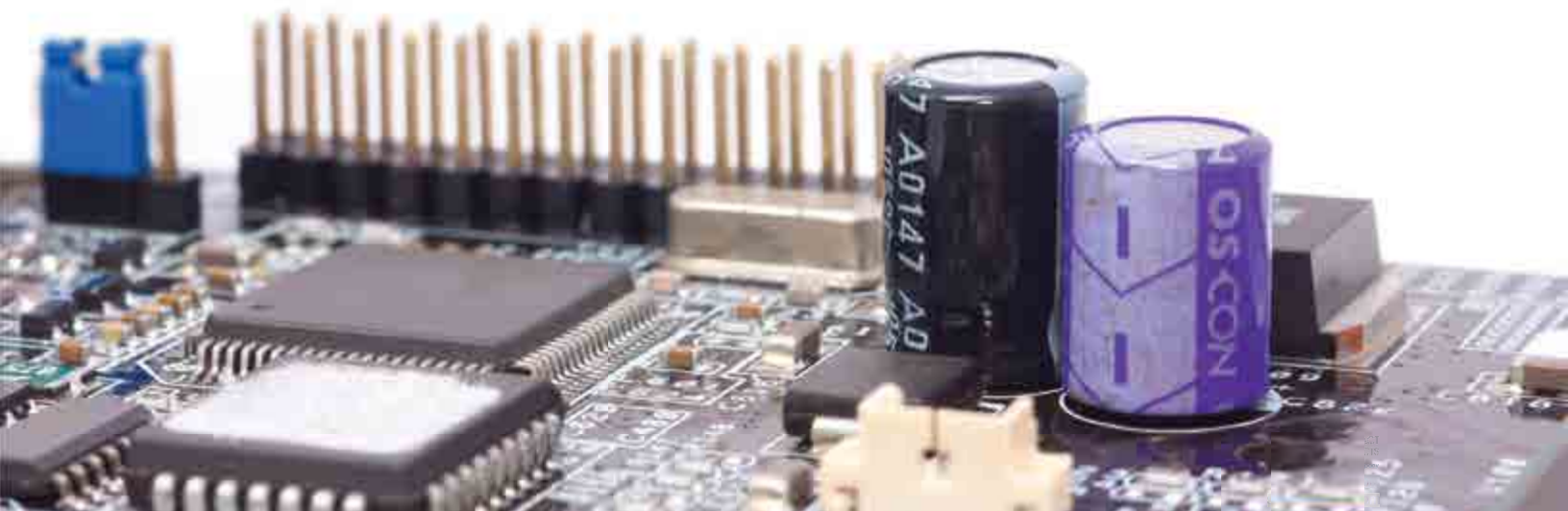

MTX-39

39 mil (1.00 mm)

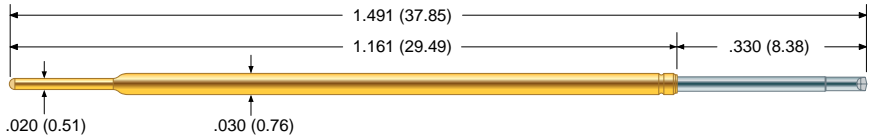

Mechanical

- Recommended Travel: .167 (4.24)
- Full Travel: .250 (6.35)
- Operating Temperature
 - Standard Spring: -55°C to +105°C
 - Alternate Spring: -55°C to +150°C
 - Elevated Spring: -55°C to +105°C

Spring Force in oz. (grams)

	Order Code	Preload	Rec. Travel
Standard	- 4	1.02 (29)	4.0 (113)
Alternate	- 6	2.15 (61)	6.0 (170)
Elevated	- 7	1.17 (33)	7.0 (198)

Electrical (Static Conditions)

- Current Rating: 3 amps
- Average Probe Resistance: < 15 mOhms

Materials and Finishes

- Plunger: High performance alloy
LFRE proprietary plating
- Barrel: BeCu, Gold plated over hard Nickel
- Spring
 - Standard: Music Wire
 - Alternate: Stainless Steel
 - Elevated: Music Wire
- Ball: Stainless Steel

Receptacle

- Hole diameter: \varnothing .028 (0.70)
- Suggested drill: #70 or 0.70 mm
- Recommended wire gauge: 28-30 AWG

Material Housing

- HPR-40T: Work-hardened Nickel Silver, Gold plated over hard Nickel
- HPR-40W: Work-hardened Nickel Silver, Gold plated over hard Nickel
- STT: Work-hardened BeCu, Gold plated over hard Nickel

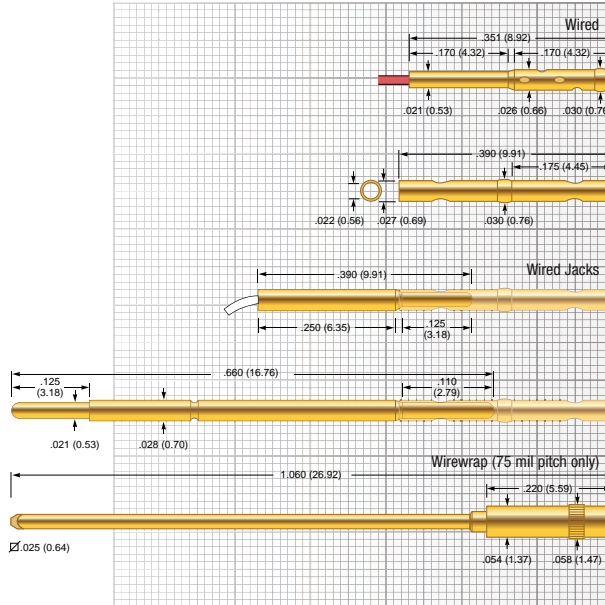

STT-80W

(Pre-wired versions -28, -30)

HPR-40W

HPR-40T with HPR-40W

HPA-40 with HPR-40W

ECR-1W-2

Tip Style

H	HC	HF	I	I8	I15	I40
\varnothing .035 (0.89)	\varnothing .024 (0.56)	\varnothing .035 (0.89)	\varnothing .019 (0.48)	\varnothing .017 (0.43)	\varnothing .017 (0.43)	\varnothing .017 (0.43)
J	T1	T20	T38	U		
\varnothing .017 (0.43)	\varnothing .019 (0.48)	\varnothing .019 (0.48)	\varnothing .038 (0.97)	\varnothing .019 (0.48)		

Termination Example

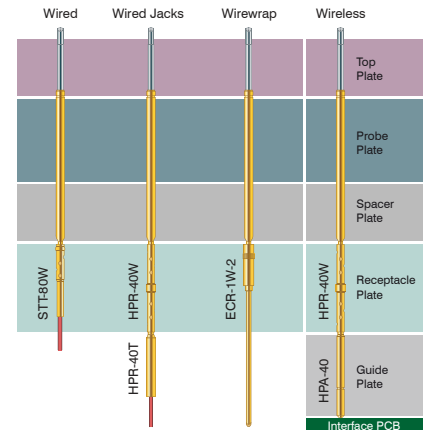

Metrix Summary

- Unified receptacles across all test center spacing
- Large variety of tips and receptacles
- Proprietary LFRE plunger plating
- Bias ball design



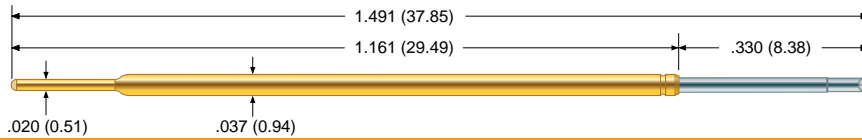

MTX-50
50 mil (1.27 mm)

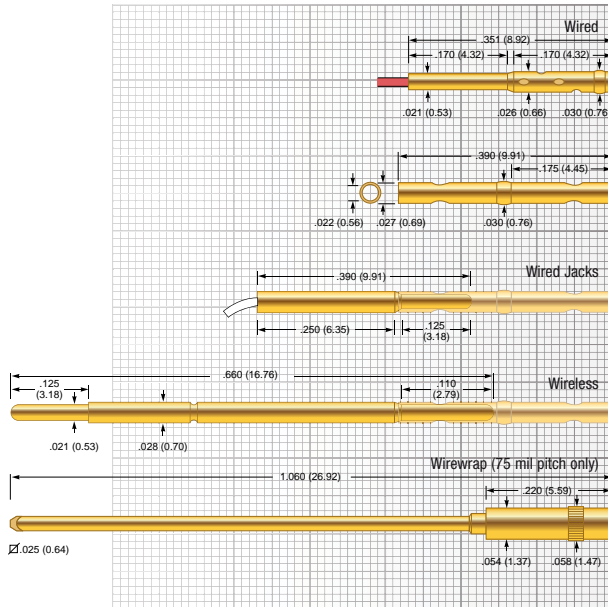

STT-80W
(Pre-wired versions -28, -30)

HPR-40W

HPR-40T with HPR-40W

HPA-40 with HPR-40W

ECR-1W-2

Mechanical

Recommended Travel: .167 (4.24)
Full Travel: .250 (6.35)
Operating Temperature: -55°C to +150°C

Spring Force in oz. (grams)

	Order Code	Preload	Rec. Travel
Standard	- 4	0.72 (20)	4.0 (113)
Alternate	- 6	2.39 (68)	6.0 (170)
Elevated	- 7	1.68 (48)	7.0 (198)
High	- 8	1.73 (49)	8.0 (227)
Ultra High	- 10	2.84 (81)	10.0 (283)

Electrical (Static Conditions)

Current Rating: 6 amps
Average Probe Resistance: <10 mOhms

Materials and Finishes

Plunger: High performance alloy
LFRE proprietary plating
Barrel: BeCu, Gold plated over hard Nickel
Spring: Stainless Steel
Ball: Stainless Steel

Receptacle

Hole diameter: Ø .028 (0.70)
Suggested drill: #70 or 0.70 mm
Recommended wire gauge: 28-30 AWG

Material Housing

- HPR-40T: Work-hardened Nickel Silver, Gold plated over hard Nickel
- HPR-40W: Work-hardened Nickel Silver, Gold plated over hard Nickel
- STT: Work-hardened BeCu, Gold plated over hard Nickel

Tip Style

H	I	I8	I15	I35	I40	J
Ø .047 (1.19)	Ø .022 (0.56)	Ø .020 (0.51)	Ø .021 (0.53)	Ø .022 (0.56)	Ø .022 (0.56)	Ø .022 (0.56)
L	L18	T	T1	T24	T30	T67
Ø .040 (1.02)	Ø .018 (0.46)	Ø .047 (1.19)	Ø .020 (0.51)	Ø .022 (0.56)	Ø .022 (0.56)	Ø .067 (1.70)
Z	Z1					
Ø .047 (1.19)	Ø .038 (0.97)					



Metrix Introduction

For test center spacing below 50mil, conventional ICT Probes reach their limits. ECT Metrix Probes overcome this issue by providing test center spacing as low as 39mil. In a conventional probe/receptacle design, the pitch is limited by the largest diameter, which typically is the diameter of the receptacle. The Metrix probe has a stepped down diameter tail. This allows the probe to be plugged into a receptacle sitting underneath the probe. Now, since the probe is placed above the receptacle, it allows you to use a receptacle with the same or lesser diameter as the probe. Valuable space is saved between the two adjacent probes which now can be placed in a tighter spacing.

Dimensions in inches (millimeters). Specifications subject to change without notice. Consult factory for other temperature requirements, and applications below -40°C. Stocking Disclaimer: Stocking levels for part numbers listed in this catalog are subject to change. Availability is based on current levels of usage and demand.



ECT CONTACT PRODUCTS
A CoNu Company
ECT-CPG.com
shop.ECT-CPG.com

MXLT-39

39 mil (1.00 mm)

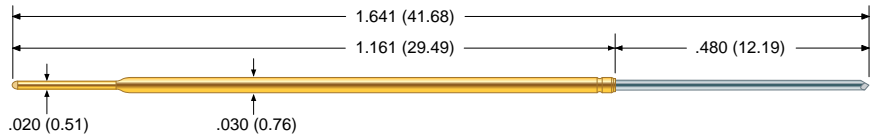

Mechanical

Recommended Travel: .315 (8.00)
Full Travel: .400 (10.16)
Operating Temperature: -55°C to +150°C

Spring Force in oz. (grams)

	Order Code	Preload	Rec. Travel
Standard	- 4.5	0.49 (14)	4.00 (113)

Electrical (Static Conditions)

Current Rating: 3 amps
Average Probe Resistance: < 15 mOhms

Materials and Finishes

Plunger: High performance alloy
LFRE proprietary plating
Barrel: BeCu, Gold plated over hard Nickel
Spring: Stainless Steel
Ball: Stainless Steel

Receptacle

Hole diameter: Ø .028 (0.70)
Suggested drill: #70 or 0.70 mm
Recommended wire gauge: 28-30 AWG

Material Housing

- HPR-40T: Work-hardened Nickel Silver, Gold plated over hard Nickel
- HPR-40W: Work-hardened Nickel Silver, Gold plated over hard Nickel
- STT: Work-hardened BeCu, Gold plated over hard Nickel

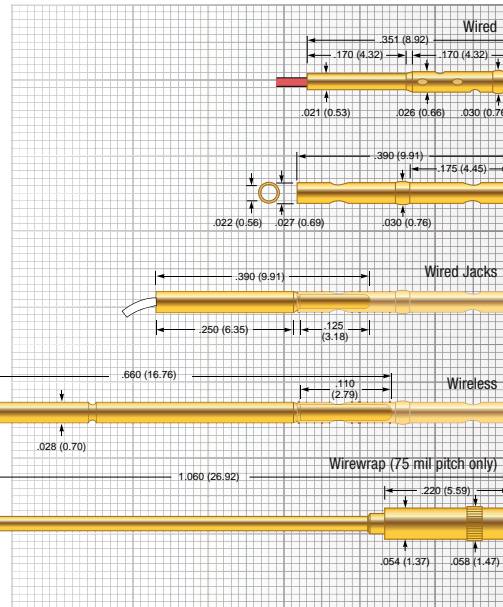

STT-80W

(Pre-wired versions -28, -30)

HPR-40W

HPR-40T with HPR-40W

HPA-40 with HPR-40W

ECR-1W-2

Tip Style

I8	I15	T20	U			
Ø .017 (0.43)	Ø .017 (0.43)	Ø .019 (0.48)	Ø .019 (0.48)			

Metrix™

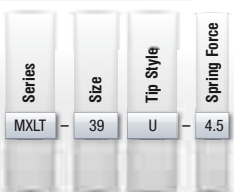

MXLT-50
50 mil (1.27 mm)

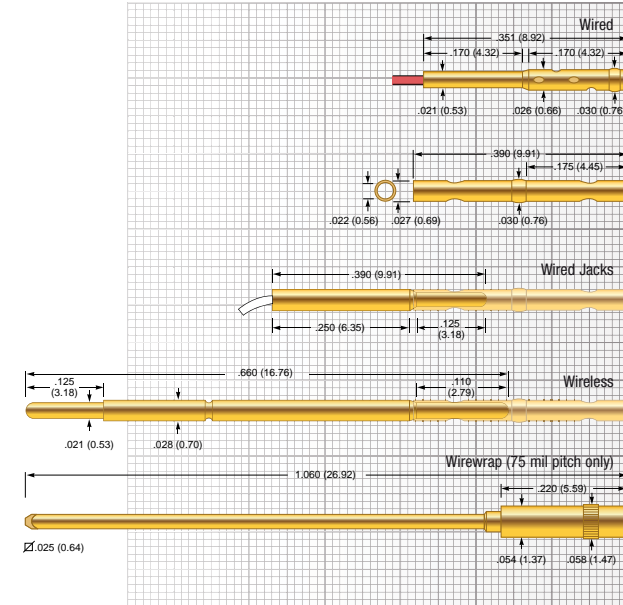
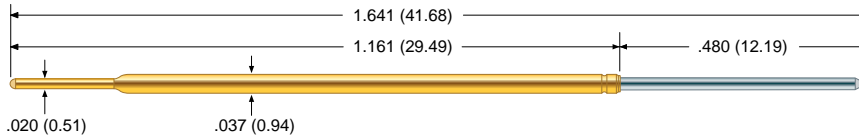

STT-80W
(Pre-wired versions -28, -30)

HPR-40W

HPR-40T with HPR-40W

HPA-40 with HPR-40W

ECR-1W-2

Mechanical

Recommended Travel:	.315 (8.00)
Full Travel:	
• Standard Spring:	.400 (10.16)
• Alternate Spring:	.350 (8.89)
• High Spring:	.350 (8.89)
Operating Temperature:	-55°C to +105°C

Spring Force in oz. (grams)

	Order Code	Preload	Rec. Travel
Standard	- 4.5	1.09 (31)	4.5 (128)
Alternate	- 7	0.75 (21)	7.0 (198)
High	- 9.6	1.50 (43)	9.6 (272)

Electrical (Static Conditions)

Current Rating:	6 amps
Average Probe Resistance:	< 10 mOhms

Materials and Finishes

Plunger:	High performance alloy LFRE proprietary plating
Barrel:	BeCu, Gold plated over hard Nickel
Spring	
Standard:	Music Wire
Alternate:	Music Wire
High:	Music Wire
Ball:	Stainless Steel

Receptacle

Hole diameter:	Ø .028 (0.70)
Suggested drill:	#70 or 0.70 mm
Recommended wire gauge:	28-30 AWG

Material Housing

- HPR-40T: Work-hardened Nickel Silver, Gold plated over hard Nickel
- HPR-40W: Work-hardened Nickel Silver, Gold plated over hard Nickel
- STT: Work-hardened BeCu, Gold plated over hard Nickel

Tip Style

B	I8	I15	L	L24	T	T24
Ø .022 (0.56)	Ø .020 (0.51)	Ø .020 (0.51)	Ø .040 (1.02)	Ø .022 (0.56)	Ø .047 (1.19)	Ø .022 (0.56)

T30
Ø .022 (0.56)



Dimensions in inches (millimeters). Specifications subject to change without notice. Consult factory for other temperature requirements, and applications below -40°C. Stocking Disclaimer: Stocking levels for part numbers listed in this catalog are subject to change. Availability is based on current levels of usage and demand.

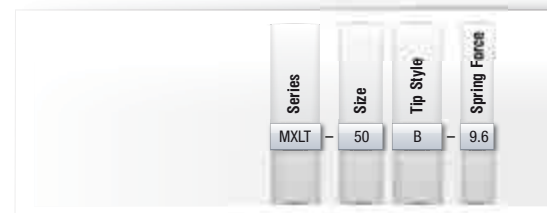

ECT LFRE: CLEANER PROBES, CLEANER ENVIRONMENT

The Lead Free Challenge

Lead free solder can cause many problems during PCBA test. Lead free solder has a higher reflow temperature which can result in harder and stickier solder flux resin and a thicker, harder oxide layer. This thicker layer of resin and oxide is more difficult to penetrate and increases wear on the pogo pin. Lead free solder resin and oxides can also increase debris transfer to spring probes. These are many of the issues found in OSP and No-Clean applications. ECT's LFRE series of test probes were specifically designed to solve these challenges.

ECT Lead Free POGO® Series

ECT's LFRE probe line incorporates a number of features that will significantly reduce the issues that arise when switching to lead free solder as well as those contact issues that arise with OSP and No-Clean solder flux.

- **LFRE Plating**

Our Lead Free probe incorporates a harder and slicker plating that not only resists wear but also reduces solder and debris transfer.

- **Higher Preload**

All of our LFRE probes incorporate higher preloads. Higher preload reduces spring force variation with board flex and increases the initial impact penetration, resulting in higher first pass yields.

- **PogoPlus® Bias Ball Design**

The PogoPlus internal bias ball design guarantees uninterrupted electrical contact with the probe sidewall virtually eliminating probe-related false opens.

- **Pointing Accuracy**

ECT's LFRE and POGO probes incorporate a double roll close, which offers the industry's best pointing accuracy. Increased pointing accuracy means the probe is less likely to touch the edge of the pad where the solder flux accumulates, a great benefit when using Lead Free solder and/or No-Clean.

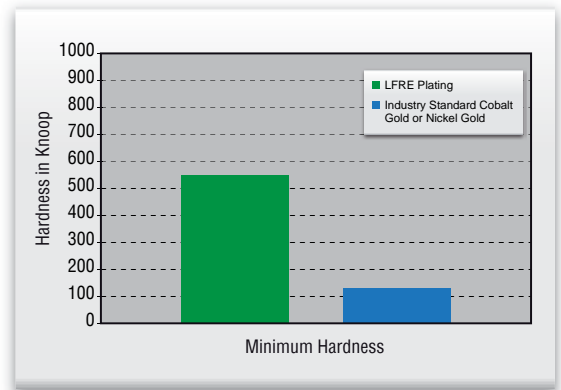

LFRE Plating vs. the Industry Standard Plating

The industry standard for plated POGO pins is gold electroplate alloyed either with cobalt or nickel to enhance its hardness. Hardness is increased from 90 Knoop for 99.7 % pure electroplated gold to 130 to 200 Knoop when alloyed with nickel or cobalt. ECT's LFRE plating is significantly harder than the industry's standard gold plating. Our new proprietary plating has a hardness range of 550 to 650 Knoop. This makes the probe tips more durable and less susceptible to solder and material transfer.



Plating

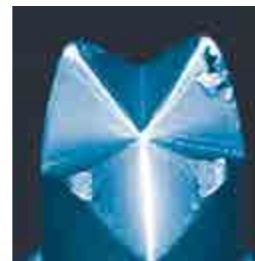

Industry Standard Gold



LFRE Plating

Contaminant Transfer



Industry Standard Gold



LFRE Plating

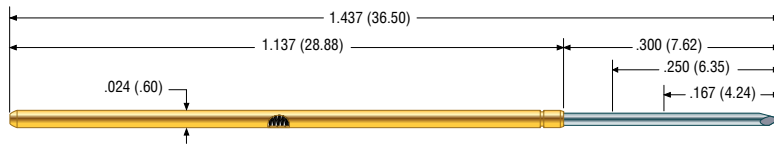

LFRE-39

39 mil (1.0 mm)

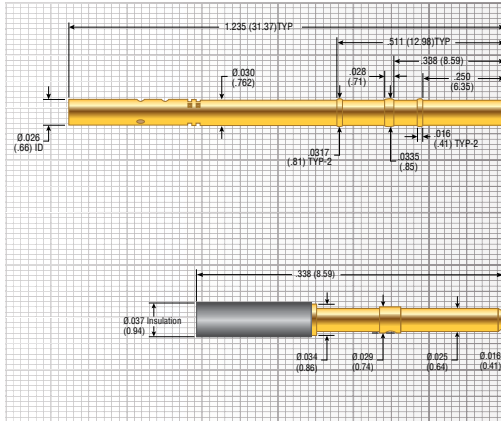

SPR-39W-S

SPT-39T
Wire Jack

Mechanical

Recommended Travel:	.167 (4.24)
Full Travel:	.250 (6.35)
Mechanical Life*:	50,000 cycles
Operating Temperature:	-55°C to +150°C

Spring Force in oz. (grams)

	Order Code	Preload	Rec. Travel
Standard	- 5.4	0.62 (18)	5.4 (153)

Electrical (Static Conditions)

Current Rating:	2 amps
Average Probe Resistance:	< 50 mOhms average

Materials and Finishes

Plunger:	High performance alloy LFRE proprietary plating
Barrel:	Nickel Silver, Gold plated
Spring:	Stainless Steel

Receptacle

Hole diameter:	Ø .0307 to .0317 (.77 to .80)
Suggested drill:	1/32" or .8 mm
SPR Housing:	Work-hardened BeCu, Gold plated over hard Nickel
SPT Housing:	Work-hardened Brass, Gold plated over hard Nickel with nylon insulator

* Life specifications are based on lab results but are dependent on cleaning frequency and the specific customer application, including DUT materials, handler kit, maintenance, etc.

Tip Style (ADDITIONAL TIPS AVAILABLE)

H	I	I15	L15	T15		
Ø .028 (.711)	Ø .015 (0.38)	Ø .015 (0.38)	Ø .015 (0.38)	Ø .015 (0.38)		



Dimensions in inches (millimeters). Specifications subject to change without notice. Consult factory for other temperature requirements, and applications below -40°C. Stocking Disclaimer: Stocking levels for part numbers listed in this catalog are subject to change. Availability is based on current levels of usage and demand.



ECP CONTACT PRODUCTS
A CoNu Company
ECT-CPG.com
shop.ECT-CPG.com

LFRE-72

50 mil (1.27 mm)

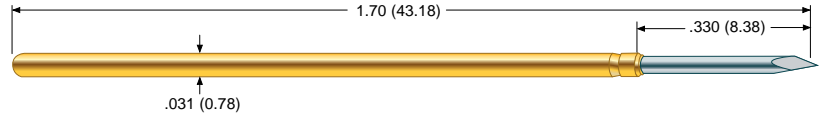

Mechanical

Recommended Travel: .167 (4.24)
 Full Travel: .250 (6.35)
 Operating Temperature: -55°C to 150°C

Spring Force in oz. (grams)

	Order Code	Preload	Rec. Travel
Light	- 2	0.60 (17)	2.0 (57)
Standard	- 4	1.53 (43)	4.0 (113)
Alternate	- 6	2.14 (61)	6.0 (170)
Elevated	- 7	2.67 (76)	7.0 (198)
High	- 8	3.12 (88)	8.0 (227)
Ultra High	- 10	3.83 (109)	10.0 (283)

Electrical (Static Conditions)

Current Rating: 3 amps
 Average Probe Resistance: < 15 mOhms

Materials and Finishes

Plunger: High performance alloy
 LFRE proprietary plating
 Barrel: Work hardened BeCu,
 Gold plated over hard Nickel
 Spring: Stainless Steel
 Ball: Stainless Steel

Receptacle

Hole diameter: Ø .039 (0.99)
 Suggested drill: #61 or 0.99 mm
 Material Housing: Hardened BeCu, Gold plated

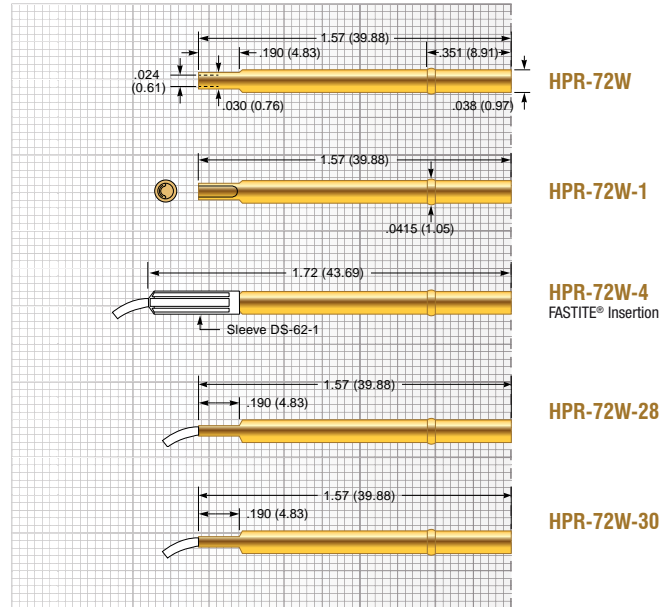

Tip Style (ADDITIONAL TIPS AVAILABLE)

H	I	I8	I15	I40	J	T1
Ø .035 (0.89)	Ø .017 (0.43)	Ø .017 (0.43)	Ø .017 (0.43)	Ø .017 (0.43)	Ø .020 (0.51)	Ø .019 (0.48)
T20	T38	U				
Ø .019 (0.48)	Ø .038 (0.97)	Ø .019 (0.48)				

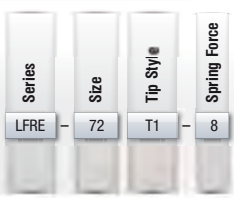

LFRE-1

75 mil (1.91 mm)

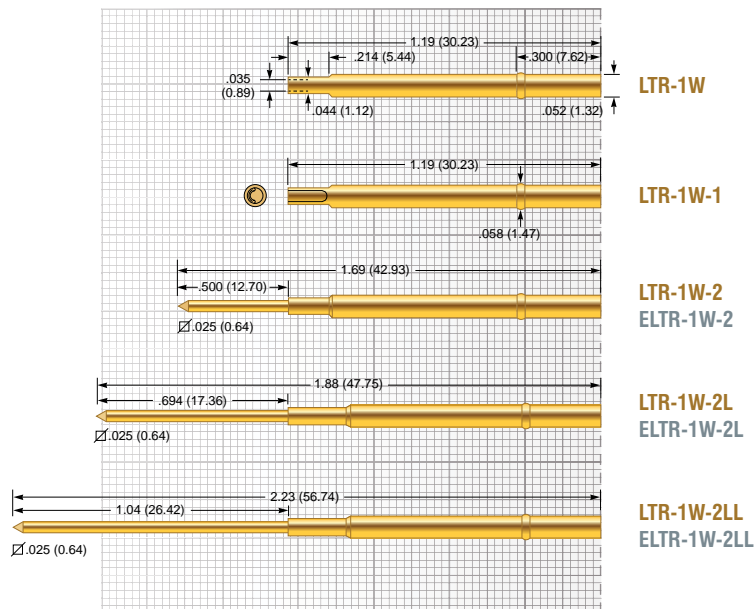
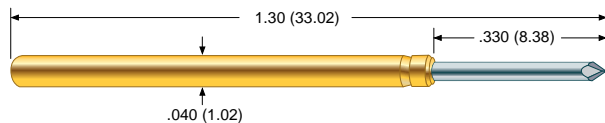

Mechanical

Recommended Travel: .167 (4.24)
 Full Travel: .250 (6.35)
 Operating Temperature: -55°C to +150°C

Spring Force in oz. (grams)

	Order Code	Preload	Rec. Travel
Light	- 2	0.83 (24)	2.0 (57)
Standard	- 4	0.62 (18)	4.0 (113)
Alternate	- 6	2.39 (68)	6.0 (170)
Elevated	- 7	1.68 (48)	7.0 (198)
High	- 8	1.73 (49)	8.0 (227)
Ultra High	-10	2.84 (81)	10.0 (283)

Electrical (Static Conditions)

Current Rating: 6 amps
 Average Probe Resistance: <10 mOhms

Materials and Finishes

Plunger: High performance alloy
 LFRE proprietary plating
 Barrel: Work hardened Phosphor Bronze,
 Gold plated over hard Nickel
 Spring: Stainless Steel
 Ball: Stainless Steel

Receptacle

Hole diameter: Ø .053 to .055 (1.35 to 1.40)
 Suggested drill: #54 or 1.40 mm

Material
 • LTR Housing: Work-hardened Nickel Silver, Gold plated over hard Nickel
 • ELTR Housing: Work-hardened Nickel Silver, unplated
 Post: Phosphorous Bronze, Gold plated

Tip Style (ADDITIONAL TIPS AVAILABLE)

A	B	H	I	I8	I15	I35
Ø .047 (1.19)	Ø .022 (0.56)	Ø .047 (1.19)	Ø .021 (0.51)	Ø .020 (0.51)	Ø .021 (0.53)	Ø .022 (0.56)
I40	J	L	L18	L24	T	T1
Ø .021 (0.53)	Ø .022 (0.56)	Ø .033 (0.84)	Ø .018 (0.46)	Ø .022 (0.56)	Ø .047 (1.19)	Ø .022 (0.56)
T24	T30	UN	V	Z	Z1	
Ø .022 (0.56)	Ø .022 (0.56)	Ø .021 (0.53)	Ø .047 (1.19)	Ø .047 (1.19)	Ø .038 (0.97)	



Dimensions in inches (millimeters). Specifications subject to change without notice. Consult factory for other temperature requirements, and applications below -40°C. Stocking Disclaimer: Stocking levels for part numbers listed in this catalog are subject to change. Availability is based on current levels of usage and demand.



CONTACT PRODUCTS
 ECT-CPG.com
 shop.ECT-CPG.com

LFRE-25

100 mil (2.54 mm)

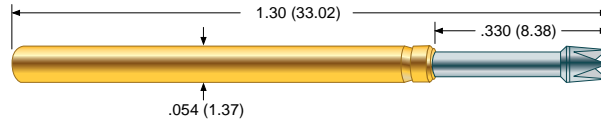

Mechanical

Recommended Travel: .167 (4.24)
 Full Travel: .250 (6.35)
 Operating Temperature: -55°C to +150°C

Spring Force in oz. (grams)

	Order Code	Preload	Rec. Travel
Light	- 2	0.75 (21)	2.0 (57)
Standard	- 4	1.50 (43)	4.0 (113)
Alternate	- 6	2.58 (73)	6.0 (170)
Elevated	- 6.5	2.65 (75)	6.5 (184)
High	- 8	2.84 (81)	8.0 (227)
Ultra High	- 10	1.77 (50)	10.0 (283)
Premium	- 12	4.49 (127)	12.0 (340)
Super	- 16	3.90 (111)	16.0 (454)

Electrical (Static Conditions)

Current Rating: 8 amps
 Average Probe Resistance: <8 mOhms

Materials and Finishes

Plunger: High performance alloy
 LFRE proprietary plating
 Barrel: Work hardened Phosphor Bronze,
 Gold plated over hard Nickel
 Spring: Stainless Steel
 Ball: Stainless Steel

Receptacle

Hole diameter: Ø .067 to .069 (1.70 to 1.75)
 Suggested drill: #51 or 1.75 mm

Material

- SPR Housing: Work-hardened Nickel Silver, Gold plated over hard Nickel

- EPR Housing: Nickel Silver, unplated

Post: Phosphorous Bronze, Gold plated

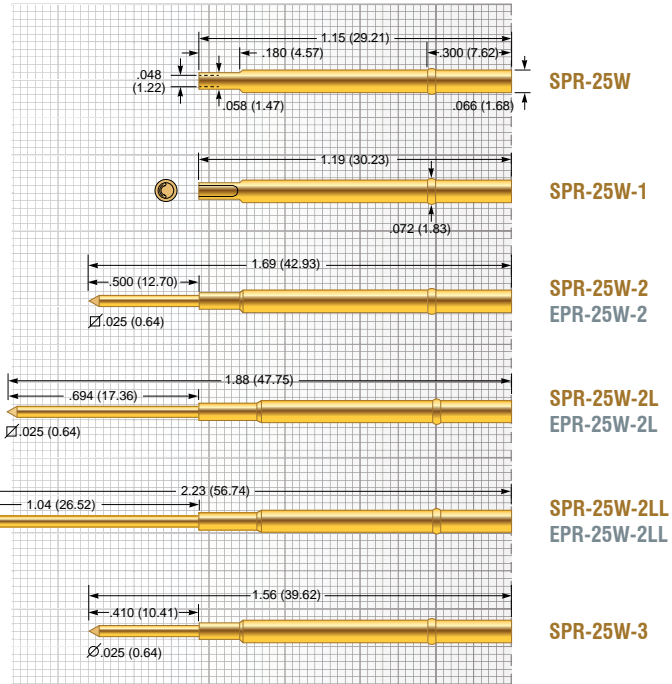

Tip Style (ADDITIONAL TIPS AVAILABLE)

A	B	H	H79	I	I8	I15
Ø .060 (1.52)	Ø .034 (0.86)	Ø .060 (1.52)	Ø .079 (2.01)	Ø .033 (0.84)	Ø .033 (0.84)	Ø .033 (0.84)
I35	I40	J	L	L18	L36	T
Ø .034 (0.86)	Ø .033 (0.84)	Ø .025 (0.64)	Ø .050 (1.27)	Ø .018 (0.46)	Ø .034 (0.86)	Ø .060 (1.52)
T1	T30	T36	T79	UN	V	Z
Ø .030 (0.74)	Ø .034 (0.86)	Ø .034 (0.86)	Ø .079 (2.01)	Ø .025 (0.64)	Ø .055 (1.40)	Ø .060 (1.52)

Z1
Ø .051 (1.30)



Page left blank intentionally



POGO-62

50 mil (1.27 mm)

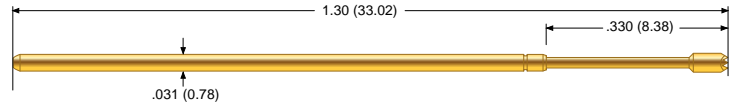

Mechanical

- Recommended Travel: .167 (4.24)
- Full Travel: .250 (6.35)
- Operating Temperature:
 - Light Spring: -55°C to +105°C
 - Standard Spring: -55°C to +105°C
 - Alternate Spring: -55°C to +150°C

Spring Force in oz. (grams)

	Order Code	Preload	Rec. Travel
Light	- 2	0.48 (14)	2.0 (57)
Standard	- 4	1.02 (29)	4.0 (113)
Alternate	- 6	2.15 (61)	6.0 (170)

Electrical (Static Conditions)

- Current Rating: 3 amps
- Average Probe Resistance: < 15 mOhms

Materials and Finishes

- Plunger: Heat-treated tool Steel, Gold plated over hard Nickel
- Barrel: Work-hardened BeCu, Gold plated over hard Nickel
- Spring:
 - Light: Music Wire
 - Standard: Music Wire
 - Alternate: Stainless Steel
- Ball: Stainless Steel

Receptacle (DER-050)

- Hole diameter: Ø .038 to .039 (0.97 to 0.99)
- Suggested drill: #61 or 0.99 mm
- Recommended Travel: .130 (3.30)
- Full Travel: .160 (4.06)
- Spring Force: 3.5 oz. (99 grams)
- Material:
 - Plunger: BeCu, Gold plated over hard Nickel
 - Barrel: BeCu, Gold plated over hard Nickel
 - Spring: Steel alloy, Gold plated over hard Nickel

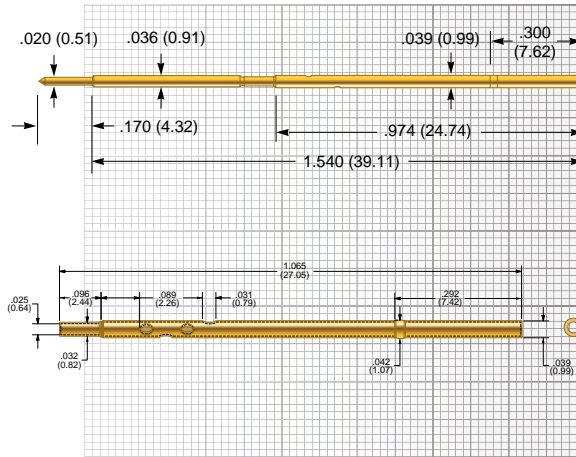

DER-050

HPR-62W-SS

Tip Style (ADDITIONAL TIPS AVAILABLE)

H...-S	I8...-S	J...-S	T1...-S	T20...-S	T38...-S	U...-S
Ø .035 (0.89)	Ø .017 (0.43)	Ø .020 (0.51)	Ø .019 (0.48)	Ø .019 (0.48)	Ø .038 (0.97)	Ø .019 (0.48)



PogoPlus Bias Ball Design

The PogoPlus internal bias ball design guarantees uninterrupted electrical contact with the probe sidewall virtually eliminating probe related false opens.



PogoPlus Bias Design

The enhanced bias-ball design forces contact between plunger and barrel wall at all times, virtually eliminating probe-related false opens.



Conventional Bias Design

Angle of spring coil end matches biased plunger end, compromising bias force and electrical contact

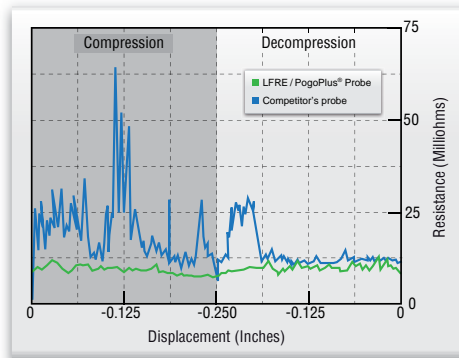

Benefit

Resistance performance comparison of a PogoPlus® bias design to a conventional bias design, during the full compression / decompression cycle of the probe.

The resistance vs. displacement graph shows the LFRE / POGO® probe has a more consistent resistivity performance resulting in significantly fewer probe false opens and tighter control of the test process.



POGO-72

50 mil (1.27 mm)

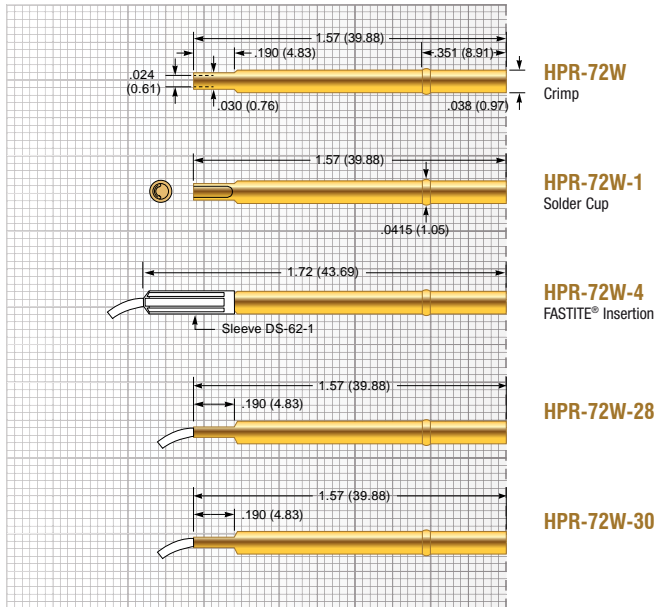

Mechanical

Recommended Travel:	.167 (4.24)
Full Travel:	.250 (6.35)

Spring Force in oz. (grams)

	Order Code	Preload	Rec. Travel
Light	- 2	0.60 (17)	2.0 (57)
Standard	- 4	1.53 (43)	4.0 (113)
Alternate	- 6	2.14 (61)	6.0 (170)
Elevated	- 7	2.67 (76)	7.0 (198)
High	- 8	3.12 (89)	8.0 (227)
Ultra High	-10	3.38 (109)	10.0 (283)

Electrical (Static Conditions)

Current Rating:	3 amps
Average Probe Resistance:	< 15 mOhms

Materials and Finishes

Plunger:	Heat-treated tool Steel or BeCu, Gold plated over hard Nickel
Barrel:	Work hardened BeCu, Gold plated over hard Nickel
Spring:	Stainless Steel
Ball:	Stainless Steel

Receptacle

Hole diameter:	Ø .039 (0.99)
Suggested drill:	#61 or 0.99 mm
Material Housing:	Hardened BeCu, Gold plated

Tip Style (ADDITIONAL TIPS AVAILABLE)

H	I...S	I8...S	J	T1...S	T20...S	T38...S
Ø .035 (0.89)	Ø .017 (0.43)	Ø .017 (0.43)	Ø .020 (0.51)	Ø .019 (0.48)	Ø .019 (0.48)	Ø .038 (0.97)

U
Ø .019 (0.48)

Tighter Pointing Tolerances

ECT Pogo contacts deliver superior pointing accuracy demonstrated by test results measuring sideload TIR.

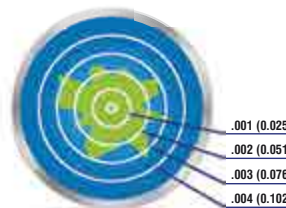

Double-Close Design

Conventional single-close probes provide marginal pointing accuracy. The double-close design of the LFRE / PogoPlus probe constrains the plunger to a tighter range of vertical motion for more accurate pointing precision.



Dimensions in inches (millimeters). Specifications subject to change without notice. Consult factory for other temperature requirements, and applications below -40°C. Stocking Disclaimer: Stocking levels for part numbers listed in this catalog are subject to change. Availability is based on current levels of usage and demand.

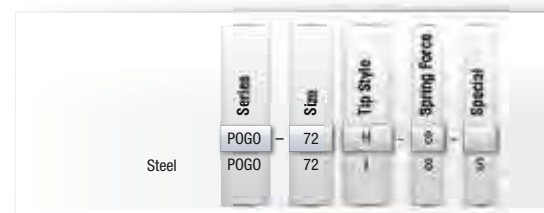

POGO-1

75 mil (1.91 mm)

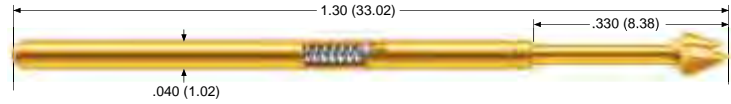

Mechanical

Recommended Travel: .167 (4.24)
 Full Travel: .250 (6.35)
 Operating Temperature: -55°C to +150°C

Spring Force in oz. (grams)

	Order Code	Preload	Rec. Travel
Light	- 2	0.83 (24)	2.0 (57)
Standard	- 4	0.62 (18)	4.0 (113)
Alternate	- 6	2.39 (68)	6.0 (170)
Elevated	- 7	1.68 (48)	7.0 (198)
High	- 8	1.73 (49)	8.0 (227)
Ultra High	- 10	2.84 (81)	10.0 (283)

Electrical (Static Conditions)

Current Rating: 6 amps
 Average Probe Resistance: <10 mOhms

Materials and Finishes

Plunger: Heat-treated tool Steel or BeCu, Gold plated over hard Nickel
 Barrel: Work hardened Phosphor Bronze, Gold plated over hard Nickel
 Spring: Stainless Steel
 Ball: Stainless Steel

Receptacle

Hole diameter: \varnothing .053 to .055 (1.35 to 1.40)
 Suggested drill: #54 or 1.40 mm
 Material

- LTR Housing: Work-hardened Nickel Silver, Gold plated over hard Nickel
 - ELTR Housing: Work-hardened Nickel Silver, unplated
- Post: Phosphorous Bronze, Gold plated

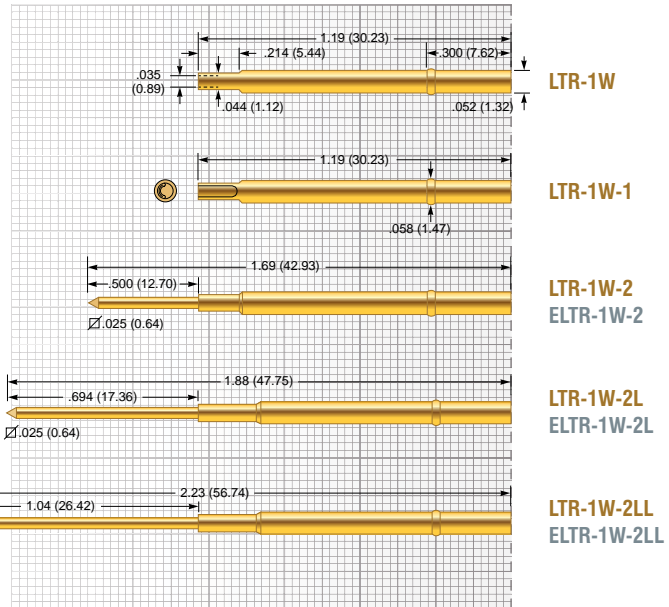

Tip Style (ADDITIONAL TIPS AVAILABLE)

A	B...-S	H	H-INS	I...-S	I8...-S	I35...-S
\varnothing .047 (1.19)	\varnothing .022 (0.56)	\varnothing .047 (1.19)	\varnothing .060 (1.52)	\varnothing .020 (0.51)	\varnothing .020 (0.51)	\varnothing .022 (0.56)
J	L	L18	L24	P	T	T1...-S
\varnothing .022 (0.56)	\varnothing .033 (0.84)	\varnothing .018 (0.46)	\varnothing .022 (0.56)	\varnothing .047 (1.19)	\varnothing .047 (1.19)	\varnothing .020 (0.51)
T24...-S	T30...-S	UN	V	Z	Z1	
\varnothing .022 (0.56)	\varnothing .022 (0.56)	\varnothing .021 (0.53)	\varnothing .047 (1.19)	\varnothing .047 (1.19)	\varnothing .038 (0.97)	

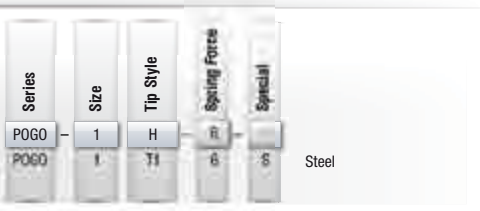

POGO-25

100 mil (2.54 mm)

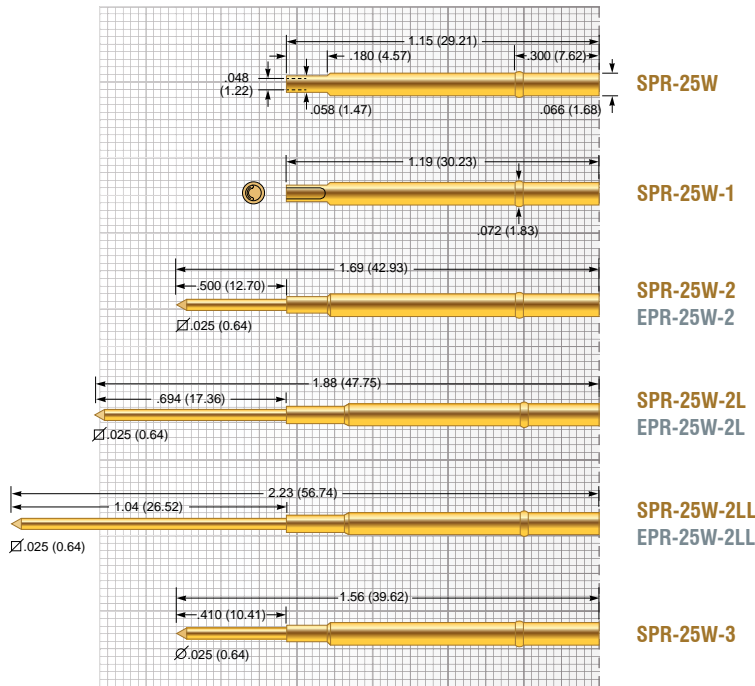

Mechanical

Recommended Travel:	.167 (4.24)
Full Travel:	.250 (6.35)
Operating Temperature	-55°C to +150°C

Spring Force in oz. (grams)

	Order Code	Preload	Rec. Travel
Light	- 2	0.75 (21)	2.0 (57)
Standard	- 4	1.50 (43)	4.0 (113)
Alternate	- 6	2.58 (73)	6.0 (170)
Elevated	- 6.5	2.65 (75)	6.5 (184)
High	- 8	2.84 (81)	8.0 (227)
Ultra High	-10	1.77 (50)	10.0 (283)
Super	-16	3.93 (111)	16.0 (455)

Electrical (Static Conditions)

Current Rating:	8 amps
Average Probe Resistance:	<8 mOhms

Materials and Finishes

Plunger:	Heat-treated tool Steel or BeCu, Gold plated over hard Nickel
Barrel:	Work hardened Phosphor Bronze, Gold plated over hard Nickel
Spring:	Stainless Steel
Ball:	Stainless Steel

Receptacle

Hole diameter:	Ø .067 to .069 (1.70 to 1.75)
Suggested drill:	#51 or 1.75 mm

- Material
- SPR Housing: Work-hardened Nickel Silver, Gold plated over hard Nickel
 - EPR Housing: Nickel Silver, unplated
- Post: Phosphorous Bronze, Gold plated

Tip Style (ADDITIONAL TIPS AVAILABLE)

A	B...-S	H	H-INS	HM	HM-INS	L...-S
Ø .060 (1.52)	Ø .034 (0.86)	Ø .060 (1.52)	Ø .085 (2.16)	Ø .122 (3.10)	Ø .140 (3.56)	Ø .033 (0.84)
I8...-S	I15...-S	I35...-S	J	L	L18	L36
Ø .033 (0.84)	Ø .033 (0.84)	Ø .034 (0.86)	Ø .025 (0.64)	Ø .050 (1.27)	Ø .018 (0.46)	Ø .034 (0.86)
T	T10...-S	T1...-S	T30...-S	T36...-S	UN	V
Ø .060 (1.52)	Ø .034 (0.86)	Ø .030 (0.74)	Ø .034 (0.86)	Ø .034 (0.86)	Ø .025 (0.64)	Ø .055 (1.40)
Z	Z1					
Ø .060 (1.52)	Ø .051 (1.30)					



Dimensions in inches (millimeters). Specifications subject to change without notice. Consult factory for other temperature requirements, and applications below -40°C. Stocking Disclaimer: Stocking levels for part numbers listed in this catalog are subject to change. Availability is based on current levels of usage and demand.

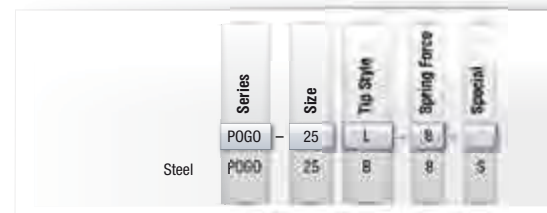

LFLT-72

50 mil (1.27 mm)

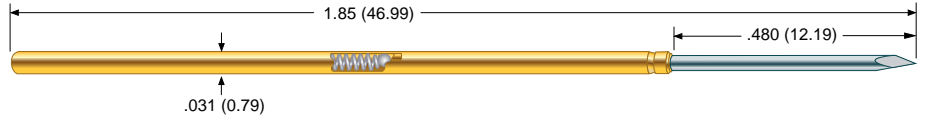

Mechanical

Recommended Travel: .317 (8.05)
 Full Travel:
 • Alternate Spring: .400 (10.16)
 • High Spring: .350 (8.89)
 Operating Temperature: -55°C to +150°C

Spring Force in oz. (grams)

	Order Code	Preload	Rec. Travel
Alternate	- 6	1.85 (52)	6.0 (170)
High	- 9	1.90 (54)	9.0 (255)

Electrical (Static Conditions)

Current Rating: 6 amps
 Average Probe Resistance: <100 mOhms

Materials and Finishes

Plunger: High performance alloy
 LFRE proprietary plating
 Barrel: Heat treated BeCu,
 Gold plated over hard Nickel
 Spring: Stainless Steel
 Ball: Stainless Steel

Receptacle

Hole diameter: Ø .039 (0.99)
 Suggested drill: #61 or 0.99 mm
 Material Housing: Hardened BeCu, Gold plated

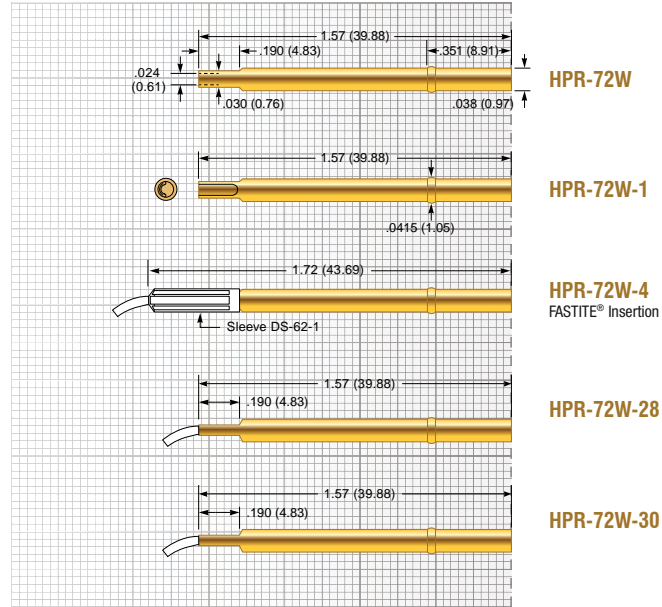

Tip Style (ADDITIONAL TIPS AVAILABLE)

H	I	I40	T38	U		
Ø .035 (0.89)	Ø .017 (0.43)	Ø .017 (0.43)	Ø .038 (0.97)	Ø .019 (0.48)		



LFLT-1

75 mil (1.91 mm)

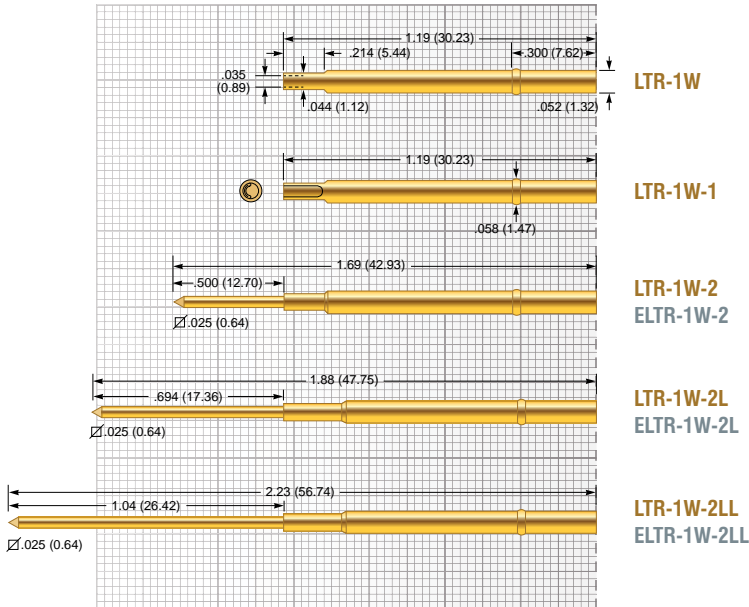
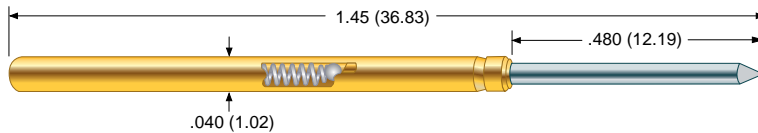

Mechanical

Recommended Travel:	.317 (8.05)
Full Travel:	
• Standard Spring:	.400 (10.16)
• Elevated Spring:	.350 (8.89)
• High Spring:	.350 (8.89)
Operating Temperature:	-55°C to +105°C

Spring Force in oz. (grams)

	Order Code	Preload	Rec. Travel
Standard	- 4.5	1.09 (31)	4.5 (128)
Elevated	- 7	0.75 (21)	7.0 (198)
High	- 9.6	1.51 (43)	9.6 (272)

Electrical (Static Conditions)

Current Rating:	6 amps
Average Probe Resistance:	< 10 mOhms

Materials and Finishes

Plunger:	High performance alloy LFRE proprietary plating
Barrel:	Work hardened Phosphor Bronze, Gold plated over hard Nickel
Spring:	
• Standard:	Music Wire
• Elevated:	Music Wire
• High:	Music Wire
Ball:	Stainless Steel

Receptacle

Hole diameter:	Ø .053 to .055 (1.35 to 1.40)
Suggested drill:	#54 or 1.40 mm
Material:	
• LTR Housing:	Work-hardened Nickel Silver, Gold plated over hard Nickel
• ELTR Housing:	Work-hardened Nickel Silver, unplated
Post:	Phosphorous Bronze, Gold plated

Tip Style (ADDITIONAL TIPS AVAILABLE)

H	I15	I40	L	T		
Ø .047 (1.19)	Ø .021 (0.53)	Ø .021 (0.53)	Ø .033 (0.84)	Ø .047 (1.19)		



Dimensions in inches (millimeters). Specifications subject to change without notice.
 Consult factory for other temperature requirements, and applications below -40°C.
 Stocking Disclaimer: Stocking levels for part numbers listed in this catalog are subject to change.
 Availability is based on current levels of usage and demand.



ECT-CPG.com
shop.ECT-CPG.com



LFLT-25

100 mil (2.54 mm)

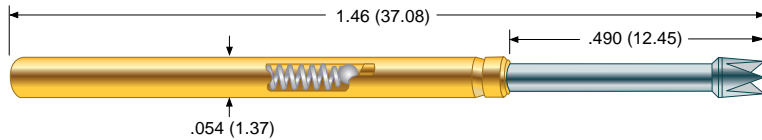

Mechanical

- Recommended Travel: .315 (8.00)
- Full Travel:
- Standard Spring: .400 (10.16)
 - Alternate Spring: .400 (10.16)
 - High Spring: .400 (10.16)
 - Ultra High Spring: .350 (8.89)
- Operating Temperature
- Standard Spring: -55°C to +105°C
 - Alternate Spring: -55°C to +105°C
 - High Spring: -55°C to +105°C
 - Ultra High Spring: -55°C to +150°C

Spring Force in oz. (grams)

	Order Code	Preload	Rec. Travel
Standard	- 4	1.08 (31)	4.0 (113)
Alternate	- 6	0.99 (28)	6.0 (170)
High	- 8	0.75 (21)	8.0 (227)
Ultra High	- 9.7	1.16 (33)	9.7 (275)

Electrical (Static Conditions)

- Current Rating: 8 amps
- Average Probe Resistance: <8 mOhms

Materials and Finishes

- Plunger: High performance alloy
LFRE proprietary plating
- Barrel: Work hardened Phosphor Bronze,
LFRE proprietary plating
- Spring
- Standard: Music Wire
 - Alternate: Music Wire
 - High: Music Wire
 - Ultra High: Stainless Steel
- Ball: Stainless Steel

Receptacle

- Hole diameter: Ø .067 to .069 (1.70 to 1.75)
- Suggested drill: #51 or 1.75 mm
- Material
- SPR Housing: Nickel Silver, Gold plated
 - EPR Housing: Nickel Silver, unplated
- Post: Phosphorous Bronze, Gold plated

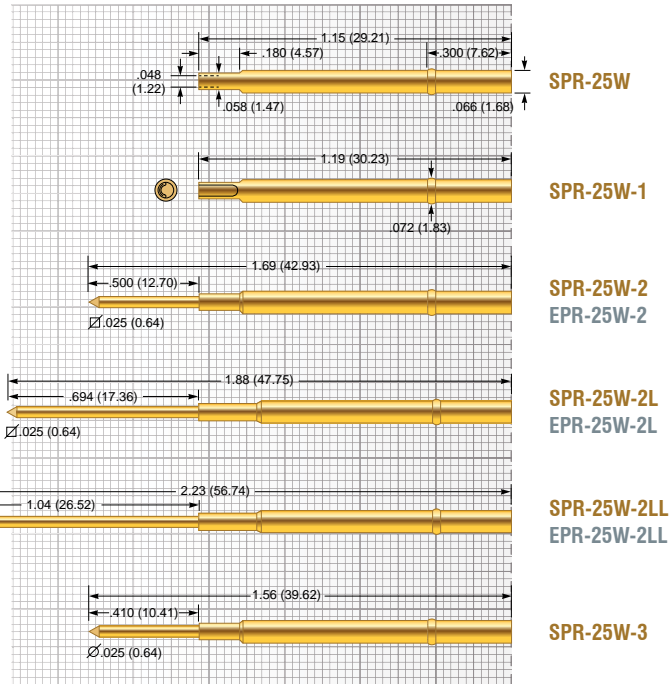

Tip Style (ADDITIONAL TIPS AVAILABLE)

H	I15	I40	J	L	T	
H = .060 (1.52)	I15 = .033 (0.84)	I40 = .033 (0.84)	J = .034 (0.86)	L = .050 (1.27)	T = .060 (1.52)	

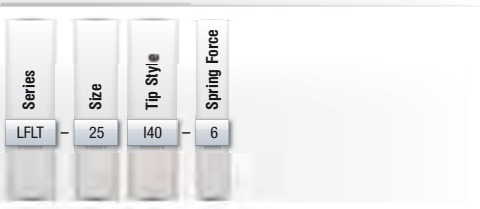

Page left blank intentionally



LTP-72

50 mil (1.27 mm)



Mechanical

Recommended Travel:	.317 (8.05)
Full Travel:	
• Alternate Spring:	.400 (10.16)
• High Spring:	.350 (8.89)
Operating Temperature:	-55°C to +150°C

Spring Force in oz. (grams)

	Order Code	Preload	Rec. Travel
Alternate	- 6	1.85 (52)	6.0 (170)
High	- 9	1.90 (54)	9.0 (255)

Electrical (Static Conditions)

Current Rating:	6 amps
Average Probe Resistance:	< 100 mOhms

Materials and Finishes

Plunger:	Heat-treated tool Steel or BeCu, Gold plated over hard Nickel
Barrel:	Work hardened Phosphor Bronze, Gold plated over hard Nickel
Spring:	Stainless Steel
Ball:	Stainless Steel

Receptacle

Hole diameter:	Ø .039 (0.99)
Suggested drill:	#61 or 0.99 mm
Material Housing:	Work-hardened BeCu, Gold plated over hard Nickel

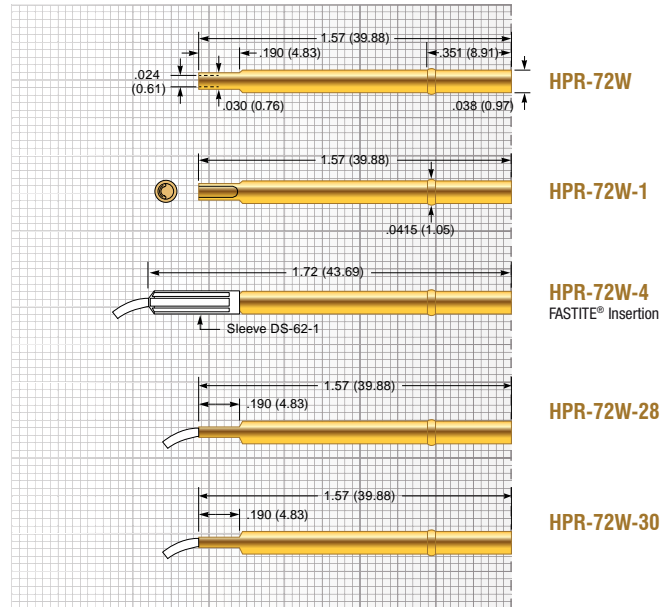

Tip Style (ADDITIONAL TIPS AVAILABLE)

I8	I15	T20	U			
Ø .017 (0.43)	Ø .017 (0.43)	Ø .019 (0.48)	Ø .019 (0.48)			



LTP-1

75 mil (1.91 mm)

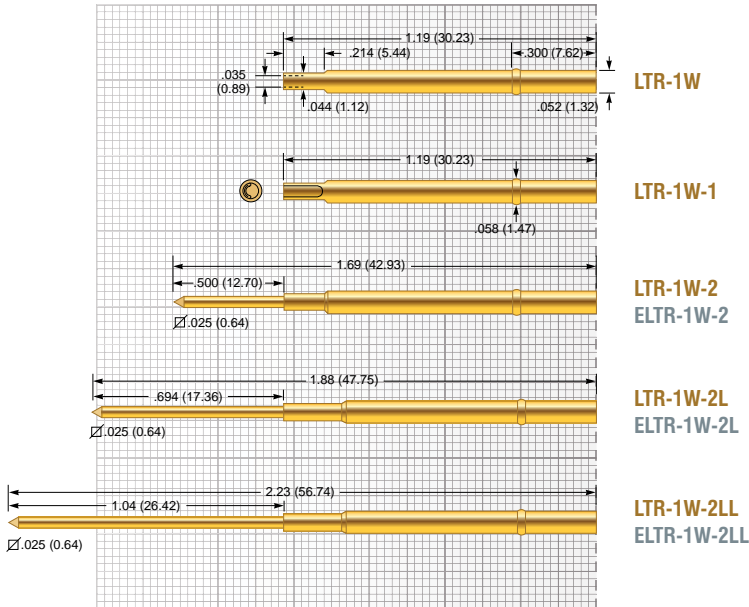
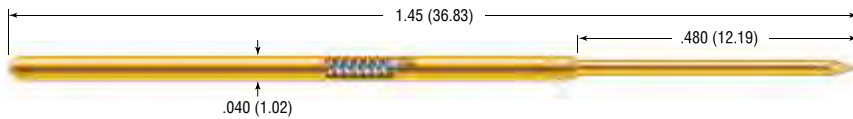

Mechanical

Recommended Travel:	.317 (8.05)
Full Travel:	
• Standard Spring:	.400 (10.16)
• Elevated Spring:	.350 (8.89)
• High Spring:	.350 (8.89)
Operating Temperature:	-55°C to +105°C

Spring Force in oz. (grams)

	Order Code	Preload	Rec. Travel
Standard	- 4.5	1.09 (31)	4.5 (128)
Elevated	- 7	0.75 (21)	7.0 (198)
High	- 9.6	1.51 (43)	9.6 (272)

Electrical (Static Conditions)

Current Rating:	6 amps
Average Probe Resistance:	< 10 mOhms

Materials and Finishes

Plunger:	Heat-treated tool Steel or BeCu, Gold plated over hard Nickel
Barrel:	Work hardened Phosphor Bronze, Gold plated over hard Nickel
Spring:	
• Standard:	Music Wire
• Elevated:	Music Wire
• High:	Music Wire
Ball:	Stainless Steel

Receptacle

Hole diameter:	Ø .053 to .055 (1.35 to 1.40)
Suggested drill:	#54 or 1.40 mm
Material:	
• LTR Housing:	Work-hardened Nickel Silver, Gold plated over hard Nickel
• ELTR Housing:	Work-hardened Nickel Silver, unplated
Post:	Phosphorous Bronze, Gold plated

Tip Style (ADDITIONAL TIPS AVAILABLE)

B	I8	I15	J	L	L24	T
Ø .022 (0.56)	Ø .020 (0.51)	Ø .020 (0.51)	Ø .022 (0.56)	Ø .033 (0.84)	Ø .022 (0.56)	Ø .047 (1.19)
T24	T30					
Ø .022 (0.56)	Ø .022 (0.56)					

Dimensions in inches (millimeters). Specifications subject to change without notice. Consult factory for other temperature requirements, and applications below -40°C. Stocking Disclaimer: Stocking levels for part numbers listed in this catalog are subject to change. Availability is based on current levels of usage and demand.

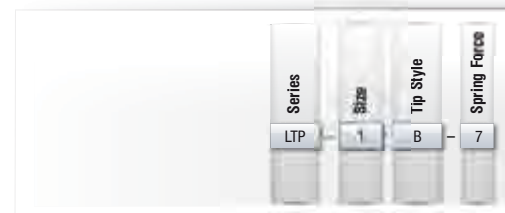

LTP-25

100 mil (2.54 mm)

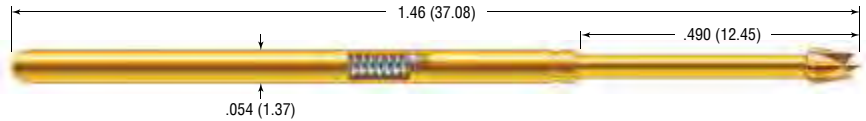

Mechanical

- Recommended Travel: .315 (8.05)
- Full Travel:
- Standard Spring: .400 (10.16)
 - Alternate Spring: .400 (10.16)
 - High Spring: .400 (10.16)
 - Ultra High Spring: .350 (8.89)
 - Only LTP-25TJ: .340 (8.60)
- Operating Temperature:
- Standard Spring: -55°C to +105°C
 - Alternate Spring: -55°C to +105°C
 - High Spring: -55°C to +105°C
 - Ultra High Spring: -55°C to +150°C

Spring Force in oz. (grams)

	Order Code	Preload	Rec. Travel
Standard	- 4	1.08 (31)	4.0 (113)
Alternate	- 6	0.99 (28)	6.0 (170)
High	- 8	0.75 (21)	8.0 (227)
Ultra High	- 9.7	2.3 (65)	9.7 (275)

Electrical (Static Conditions)

- Current Rating: 8 amps
- Average Probe Resistance: < 8 mOhms

Materials and Finishes

- Plunger: Heat-treated tool Steel or BeCu, Gold plated over hard Nickel
- Barrel: Work hardened Phosphor Bronze, Gold plated over hard Nickel
- Spring
- Standard: Music Wire
 - Alternate: Music Wire
 - High: Music Wire
 - Ultra High: Stainless Steel
- Ball: Stainless Steel

Receptacle

- Hole diameter: Ø .067 to .069 (1.70 to 1.75)
- Suggested drill: #51 or 1.75 mm

Material

- SPR Housing: Work-hardened Nickel Silver, Gold plated over hard Nickel
 - EPR Housing: Nickel Silver, unplated
- Post: Phosphorous Bronze, Gold plated

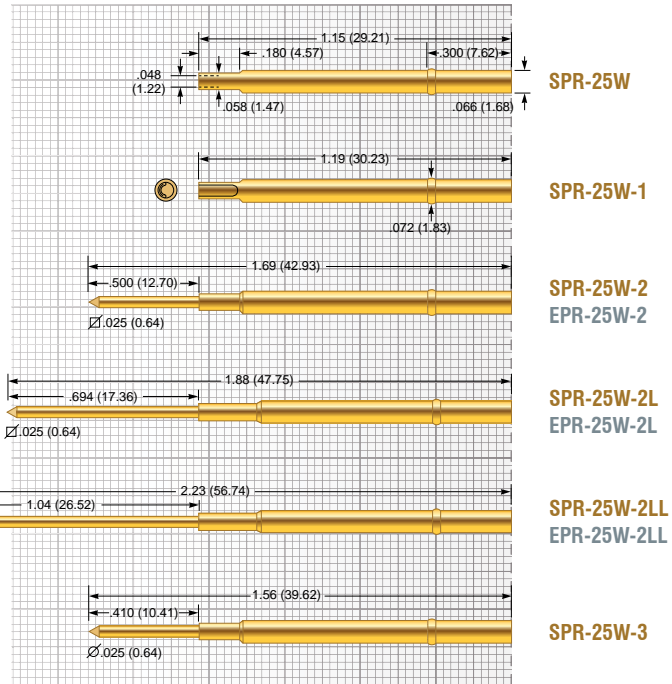

Tip Style (ADDITIONAL TIPS AVAILABLE)

A	H	I8	L	L36	T	T36
Ø .060 (1.52)	Ø .060 (1.52)	Ø .035 (0.89)	Ø .050 (1.27)	Ø .036 (0.91)	Ø .060 (1.52)	Ø .035 (0.89)
TJ	Z					
Ø .025 (0.64)	Ø .060 (1.52)					



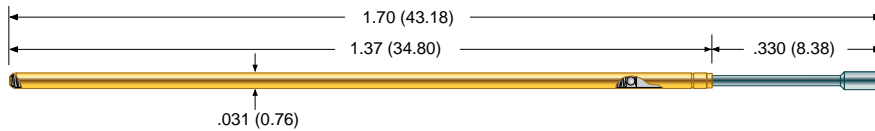

BTP-72
50 mil (1.27 mm)

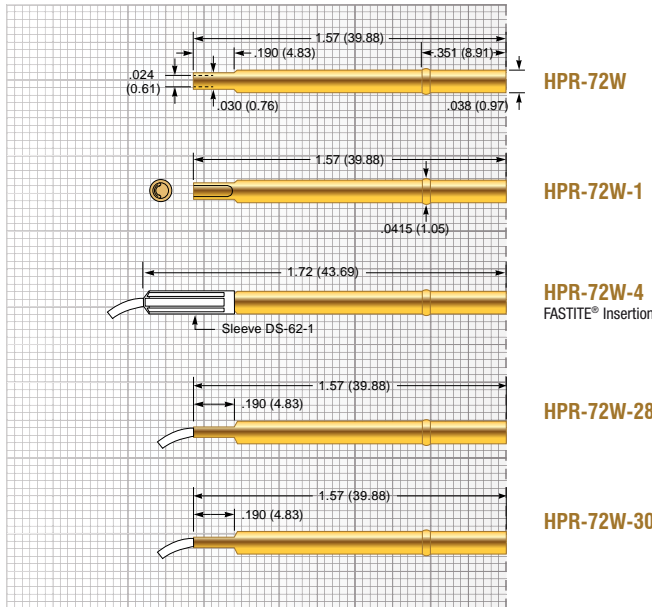

Mechanical

Recommended Travel: .167 (4.24)
 Full Travel: .250 (6.35)
 Operating Temperature: -55°C to +150°C

Spring Force in oz. (grams)

	Order Code	Preload	Rec. Travel
Light	- 2	0.60 (17)	2.0 (57)
Standard	- 4	1.53 (43)	4.0 (113)
Alternate	- 6	2.14 (61)	6.0 (170)
Elevated	- 7	2.67 (76)	7.0 (198)
High	- 8	3.12 (88)	8.0 (227)
Ultra High	- 10	3.38 (96)	10.0 (283)

Electrical (Static Conditions)

Current Rating: 3 amps
 Average Probe Resistance: <15 mOhms

Materials and Finishes

Plunger: High performance alloy
 LFRE proprietary plating
 Barrel: Heat treated BeCu,
 Gold plated over hard Nickel
 Spring: Stainless Steel
 Ball: Stainless Steel

Receptacle

Hole diameter: Ø .039 (0.99)
 Suggested drill: #61 or 0.99 mm

Material Housing: Hardened BeCu, Gold plated

Tip Style (ADDITIONAL TIPS AVAILABLE)

F	HC	HF			
Ø .035 (0.89)	Ø .024 (0.56)	Ø .035 (0.89)			

BTP SERIES BEAD TARGET PROBES

Introduction – What is Bead Probe technology?

ECT is supporting the development of the Keysight Technologies Medalist Bead Probe Technology with OEM's, contract manufacturers, and test fixture partners. Bead Probing is a methodology for placing test points directly on a PCB's copper traces, or top metal, thus forming a "Bead Probe". These Bead Probes are then contacted by "Bead Target Probes" during in-circuit testing for expanded test access. For more information, visit Keysight website: www.keysight.com, search word bead probe. There is a flash demo on the Keysight website for your review.

Features

ECT has developed a series of probes specifically for Bead Probe applications featuring:

- Pogo Plus® Design
- LFRE Plating
- Flat and "Micro-Textured" Tips

Dimensions in inches (millimeters). Specifications subject to change without notice. Consult factory for other temperature requirements, and applications below -40°C. Stocking Disclaimer: Stocking levels for part numbers listed in this catalog are subject to change. Availability is based on current levels of usage and demand.



BTP-1

75 mil (1.91 mm)

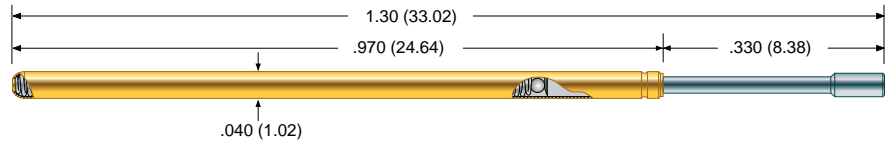

Mechanical

Recommended Travel: .167 (4.24)
 Full Travel: .250 (6.35)
 Operating Temperature: -55°C to +150°C

Spring Force in oz. (grams)

	Order Code	Preload	Rec. Travel
Light	- 2	0.83 (24)	2.0 (57)
Standard	- 4	0.62 (18)	4.0 (113)
Alternate	- 6	2.39 (68)	6.0 (170)
Elevated	- 7	1.68 (48)	7.0 (198)
High	- 8	1.73 (49)	8.0 (227)

Electrical (Static Conditions)

Current Rating: 6 amps
 Average Probe Resistance: < 10 mOhms

Materials and Finishes

Plunger: High performance alloy
 LFRE proprietary plating
 Barrel: Work hardened Phosphor Bronze,
 Gold plated over hard Nickel
 Spring: Stainless Steel
 Ball: Stainless Steel

Receptacle

Hole diameter: Ø .053 to .055 (1.35 to 1.40)
 Suggested drill: #54 or 1.40 mm
 Material
 • LTR Housing: Work-hardened Nickel Silver, Gold plated over hard Nickel
 • ELTR Housing: Work-hardened Nickel Silver, unplated
 Post: Phosphorous Bronze, Gold plated

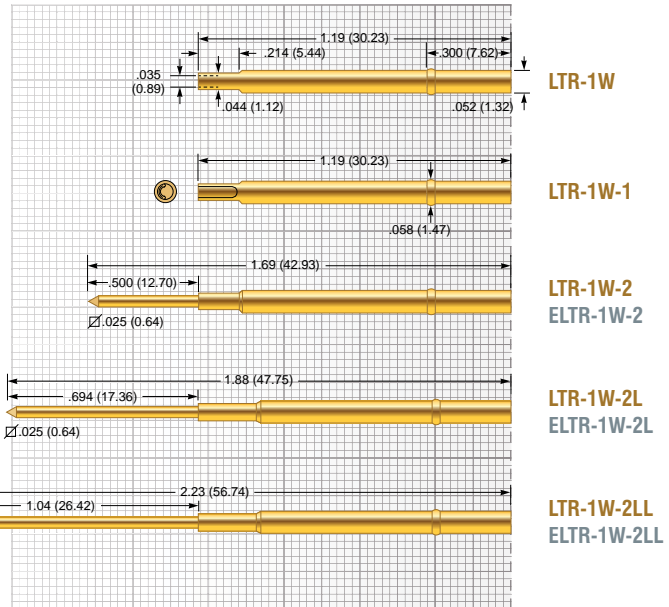

Tip Style

C	F	HC	HF	HL		
Ø .035 (0.89)	Ø .047 (1.19)	Ø .022 (0.56)	Ø .035 (0.89)	Ø .047 (1.19)		

MICRO STRUCTURED TIP

The hemi-ellipsoid shape of a Bead Probes presents a unique probing challenge in that standard serrated probes may fall into the valleys between serrations. ECT has developed a new textured tip face that is optimized for contact to the hemi-ellipsoid shape of Bead Probes as small as .004".

An innovative "Micro-Textured" tip incorporates closely spaced triangular pyramid shapes to form a textured surface. Perfect for contacting beads that are long yet have a small width when placed on a PCB trace.

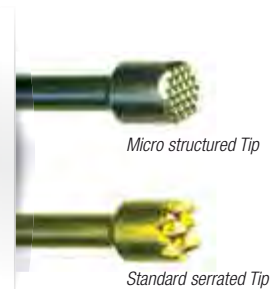

Series	Size	Tip Style	Spring Force
BTP	1	HF	8



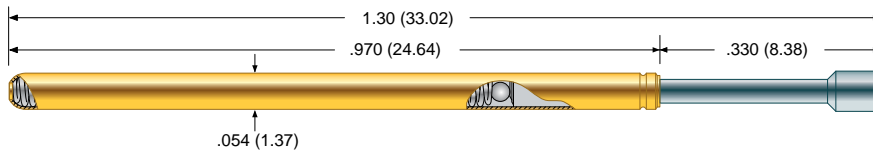

BTP-25
100 mil (2.54 mm)

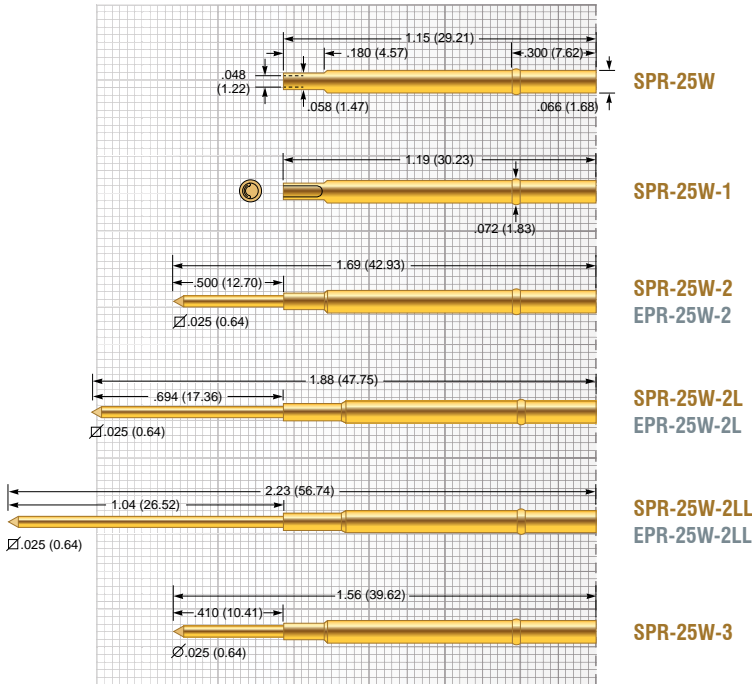

Mechanical

Recommended Travel: .167 (4.24)
Full Travel: .250 (6.35)
Operating Temperature: -55°C to +150°C

Spring Force in oz. (grams)

	Order Code	Preload	Rec. Travel
Light	- 2	0.75 (21)	2.0 (57)
Standard	- 4	1.50 (43)	4.0 (113)
Alternate	- 6.5	2.65 (75)	6.5 (184)
High	- 8	2.84 (81)	8.0 (227)
Ultra High	- 10	1.77 (50)	10.0 (283)

Electrical (Static Conditions)

Current Rating: 8 amps
Average Probe Resistance: <8 mOhms

Materials and Finishes

Plunger: High performance alloy
LFRE proprietary plating
Barrel: Work hardened Phosphor Bronze,
Gold plated over hard Nickel
Spring: Stainless Steel
Ball: Stainless Steel

Receptacle

Hole diameter: Ø .067 to .069 (1.70 to 1.75)
Suggested drill: #51 or 1.75 mm
Material
• SPR Housing: Work-hardened Nickel Silver,
Gold plated over hard Nickel
• EPR Housing: Nickel Silver, unplated
Post: Phosphorous Bronze, Gold plated

Tip Style

C	F	HF	HL			
Ø .035 (0.89)	Ø .060 (1.52)	Ø .035 (0.89)	Ø .060 (1.52)			

Dimensions in inches (millimeters). Specifications subject to change without notice. Consult factory for other temperature requirements, and applications below -40°C. Stocking Disclaimer: Stocking levels for part numbers listed in this catalog are subject to change. Availability is based on current levels of usage and demand.

Series: BTP - Size: 25 - Tip Style: C - Spring Force: 10



ECT-CPG.com
shop.ECT-CPG.com

BPLT-1

75 mil (1.91 mm)

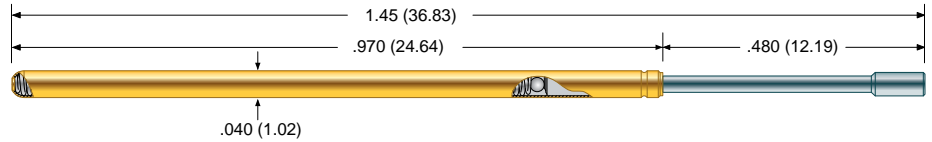

Mechanical

Recommended Travel: .317 (8.05)
 Full Travel: .350 (8.89)
 Operating Temperature: -55°C to +105°C

Spring Force in oz. (grams)

	Order Code	Preload	Rec. Travel
Standard	- 4.5	1.09 (31)	4.5 (128)
High	- 9.6	1.50 (43)	9.6 (272)

Electrical (Static Conditions)

Current Rating: 6 amps
 Average Probe Resistance: < 10 mOhms

Materials and Finishes

Plunger: High performance alloy
 LFRE proprietary plating
 Barrel: Work hardened Phosphor Bronze,
 Gold plated over hard Nickel
 Spring: Music Wire
 Ball: Stainless Steel

Receptacle

Hole diameter: Ø .053 to .055 (1.35 to 1.40)
 Suggested drill: #54 or 1.40 mm
 Material
 • LTR Housing: Work-hardened Nickel Silver, Gold plated over hard Nickel
 • ELTR Housing: Work-hardened Nickel Silver, unplated
 Post: Phosphorous Bronze, Gold plated

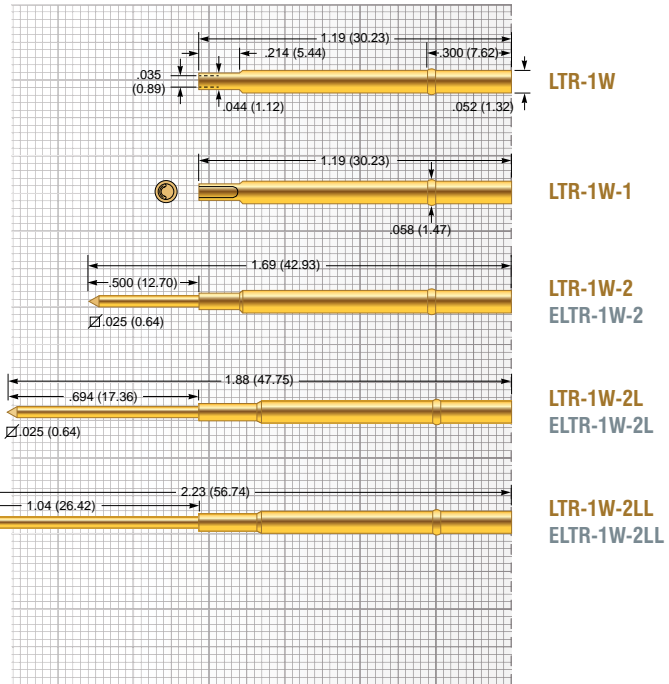

Tip Style

C	F	HF	HL			
Ø .035 (0.89)	Ø .047 (1.19)	Ø .035 (0.89)	Ø .047 (1.19)			



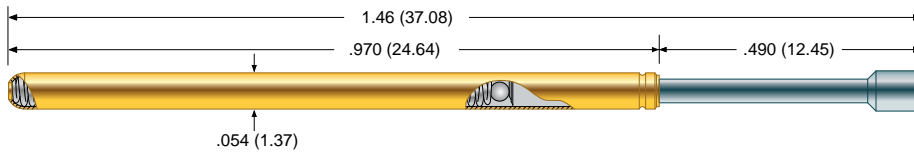

BPLT-25

100 mil (2.54 mm)

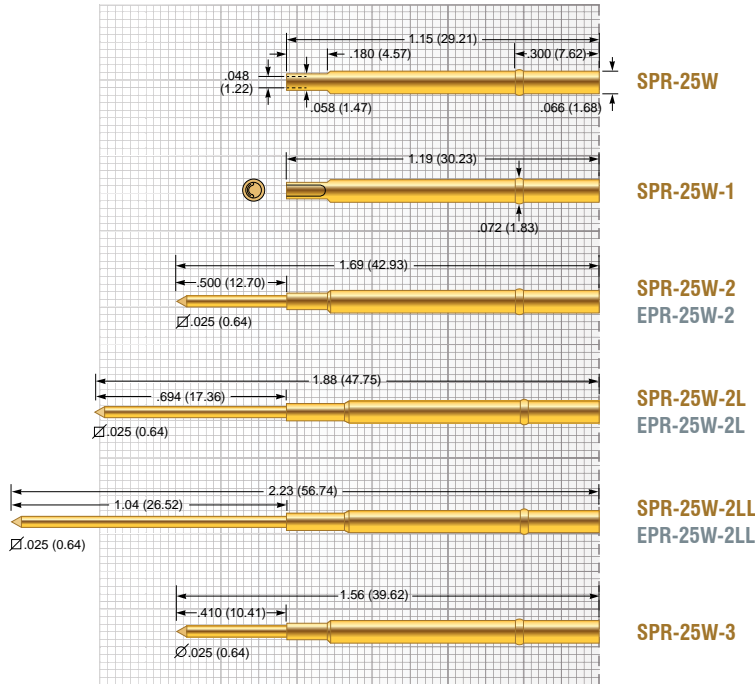

Mechanical

- Recommended Travel: .317 (8.05)
- Full Travel: .350 (8.89)
- Operating Temperature:
 - Standard Spring: -55°C to +105°C
 - Alternate Spring: -55°C to +105°C
 - High Spring: -55°C to +105°C
 - Ultra High Spring: -55°C to +150°C

Spring Force in oz. (grams)

	Order Code	Preload	Rec. Travel
Standard	- 4	1.08 (31)	4.0 (113)
Alternate	- 6	0.99 (28)	6.0 (170)
High	- 8	0.75 (21)	8.0 (227)
Ultra High	- 9.7	1.16 (33)	9.7 (275)

Electrical (Static Conditions)

- Current Rating: 8 amps
- Average Probe Resistance: <8 mOhms

Materials and Finishes

- Plunger: High performance alloy
LFRE proprietary plating
- Barrel: Work hardened Phosphor Bronze,
Gold plated over hard Nickel
- Spring
 - Standard: Music Wire
 - Alternate: Music Wire
 - High: Music Wire
 - Ultra High: Stainless Steel
- Ball: Stainless Steel

Receptacle

- Hole diameter: Ø .067 to .069 (1.70 to 1.75)
- Suggested drill: #51 or 1.75 mm
- Material
 - SPR Housing: Work-hardened Nickel Silver,
Gold plated over hard Nickel
 - EPR Housing: Nickel Silver, unplated
- Post: Phosphorous Bronze, Gold plated

Tip Style

C	F	HF	HL			
Ø .035 (0.89)	Ø .060 (1.52)	Ø .035 (0.89)	Ø .060 (1.52)			

Dimensions in inches (millimeters). Specifications subject to change without notice. Consult factory for other temperature requirements, and applications below -40°C. Stocking Disclaimer: Stocking levels for part numbers listed in this catalog are subject to change. Availability is based on current levels of usage and demand.

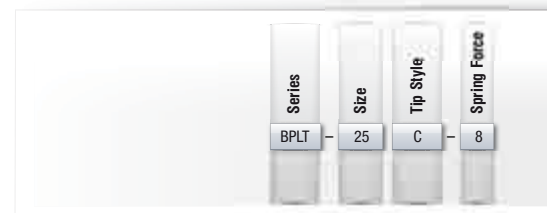

ECT-CPG.com
shop.ECT-CPG.com

PP-3070

**GSP-2B
GSP-2BL**



ECT is your source for interface probes for all major brands of test systems, including Teradyne, GenRad and Hewlett-Packard. In fact, two of these companies specify ECT probes as original equipment.

If our standard products don't meet your requirements, contact Everett Charles Technologies for expert assistance in designing and manufacturing your custom interface probe.



PP-3070

Personality Pins

Part number: PP-3070-S
Keysight Part number: Mint Pins 44275P
Packing unit: 200 pieces (strip)

Application

Used on fixture interfaces as bottom transfer pins.

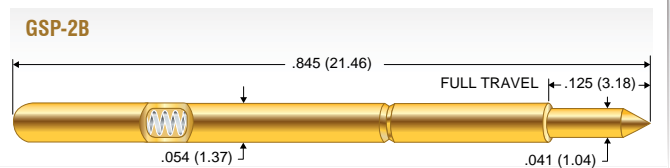

Application GenRad 227x, Pylon, Rhode&Schwarz

Mechanical

Recommended Travel: .125 (3.18)
Full Travel: .125 (3.18)
Operating Temperature: -55°C to +105°C

Spring Force in oz. (grams)

	Preload	Rec. Travel
Standard	2.5 (71)	4.5 (128)

Electrical (Static Conditions)

Current Rating: 5 amps
Average Probe Resistance: < 35 mOhms

Materials and Finishes

Plunger: Heat-treated BeCu, Gold plated over hard Nickel
Barrel: Work-hardened Nickel Silver, Gold plated over hard Nickel
Spring: Music Wire, Gold plated

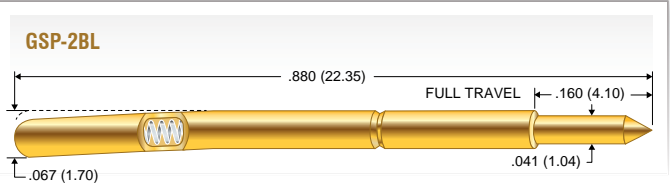

Application GenRad 227x, Pylon, Rhode&Schwarz

Mechanical

Recommended Travel: .080 (2.03)
Full Travel: .160 (4.10)
Operating Temperature: -55°C to +105°C

Spring Force in oz. (grams)

	Preload	Rec. Travel
Long	2.5 (71)	4.5 (128)

Electrical (Static Conditions)

Current Rating: 5 amps
Average Probe Resistance: < 35 mOhms

Materials and Finishes

Plunger: Heat-treated BeCu, Gold plated over hard Nickel
Barrel: Work-hardened Nickel Silver, Gold plated over hard Nickel
Spring: Music Wire, Gold plated



Dimensions in inches (millimeters). Specifications subject to change without notice. Consult factory for other temperature requirements, and applications below -40°C. Stocking Disclaimer: Stocking levels for part numbers listed in this catalog are subject to change. Availability is based on current levels of usage and demand.

RSP-2T FRP-25T

POGO-25HM-4 POGO-25T-4

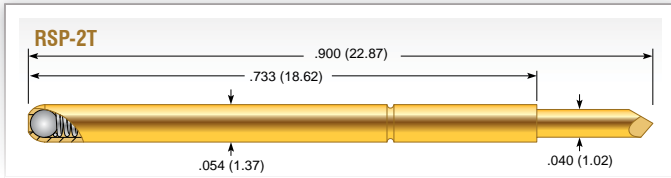

Application Rhode&Schwarz

Mechanical

Recommended Travel: .079 (2.00)
 Full Travel: .167 (4.25)
 Operating Temperature: -55°C to +105°C

Spring Force in oz. (grams)

	Preload	Rec. Travel
Standard	1.44 (41)	3.6 (102)

Electrical (Static Conditions)

Current Rating: 5 amps
 Average Probe Resistance: <20 mOhms

Materials and Finishes

Plunger: Heat-treated BeCu, Gold plated over hard Nickel
 Barrel: Nickel Silver, Gold plated
 Spring: Music Wire, Silver plated
 Ball: Stainless Steel

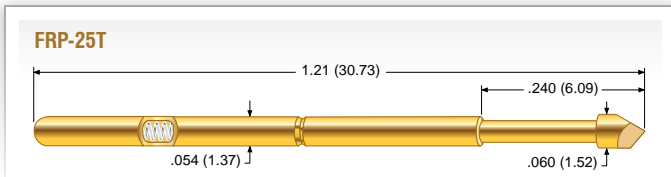

Application Schlumberger, Fagron

Mechanical

Recommended Travel: .120 (3.05)
 Full Travel: .160 (4.06)
 Operating Temperature: -55°C to +150°C

Spring Force in oz. (grams)

	Preload	Rec. Travel
Standard	0.92 (26)	4.0 (113)

Electrical (Static Conditions)

Current Rating: 5 amps
 Average Probe Resistance: <35 mOhms

Materials and Finishes

Plunger: Heat-treated BeCu, Gold plated over hard Nickel
 Barrel: Work-hardened Phosphor Bronze, Gold plated over hard Nickel
 Spring: Stainless Steel

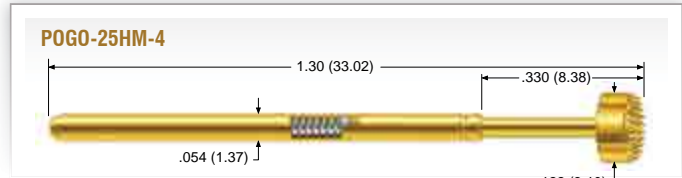

Application Keysight/Agilent / HP-3070

Mechanical

Recommended Travel: .167 (4.24)
 Full Travel: .250 (6.35)
 Operating Temperature: -55°C to +150°C

Spring Force in oz. (grams)

	Order Code	Preload	Rec. Travel
Standard	- 4	1.50 (43)	4.0 (113)

Electrical (Static Conditions)

Current Rating: 8 amps
 Average Probe Resistance: <8 mOhms

Materials and Finishes

Plunger: Heat-treated BeCu, Gold plated over hard Nickel
 Barrel: Phosphor Bronze, Gold plated over hard Nickel
 Spring: Stainless Steel
 Ball: Stainless Steel

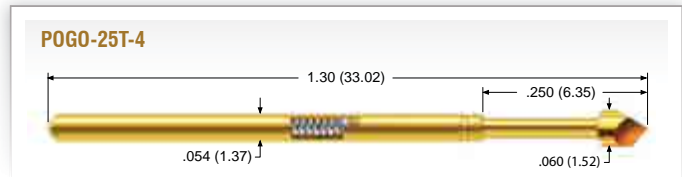

Application Teradyne 800 / 1800 / Spectrum
 Teradyne #092-431-00

Mechanical

Recommended Travel: .167 (4.24)
 Full Travel: .250 (6.35)
 Operating Temperature: -55°C to +150°C

Spring Force in oz. (grams)

	Order Code	Preload	Rec. Travel
Standard	- 4	1.50 (43)	4.0 (113)

Electrical (Static Conditions)

Current Rating: 8 amps
 Average Probe Resistance: <8 mOhms

Materials and Finishes

Plunger: Heat-treated BeCu, Gold plated over hard Nickel
 Barrel: Phosphor Bronze, Gold plated over hard Nickel
 Spring: Stainless Steel
 Ball: Stainless Steel

Dimensions in inches (millimeters). Specifications subject to change without notice. Consult factory for other temperature requirements, and applications below -40°C. Stocking Disclaimer: Stocking levels for part numbers listed in this catalog are subject to change. Availability is based on current levels of usage and demand.



SIP-90 GPP-95

SIP-90-2

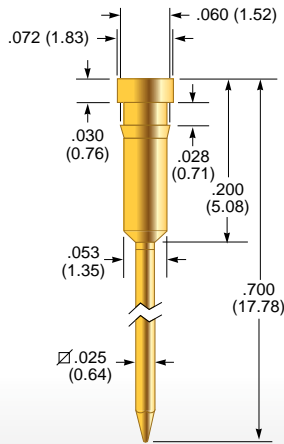

Application GenRad
Material Brass, Gold plated
Hole diameter $\varnothing .055 (1.40)$
Suggested drill #54 or 1.40 mm

SIP-90-3

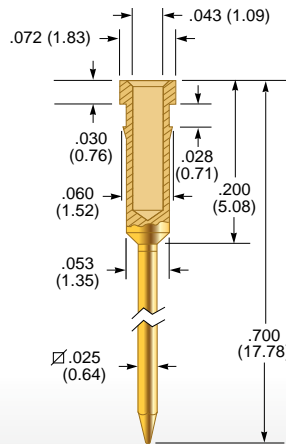

Application Factron
Material Brass, Gold plated
Hole diameter $\varnothing .055 (1.40)$
Suggested drill #54 or 1.40 mm

SIP-90-4

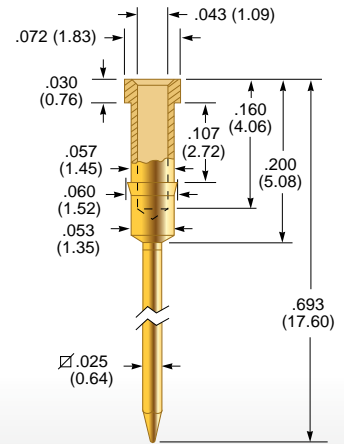

Application General Interconnect
Material Brass, Gold plated
Hole diameter $\varnothing .057 (1.45)$
Suggested drill 1.45 mm

SIP-90-5

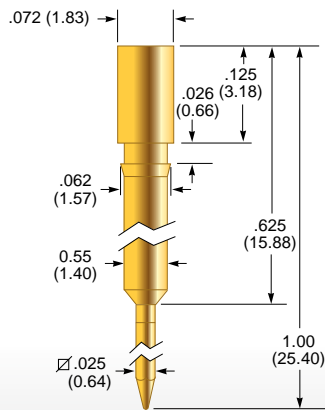

Application Zehntel
Material Brass, Gold plated
Hole diameter $\varnothing .055 (1.40)$
Suggested drill #54 or 1.40 mm

SIP-90-6

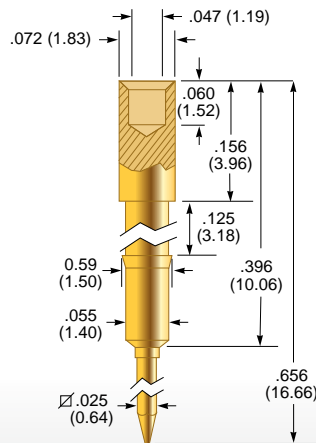

Application General Interconnect
Material Brass, Gold plated
Hole diameter $\varnothing .057 (1.45)$
Suggested drill 1.45 mm

GPP-95-2

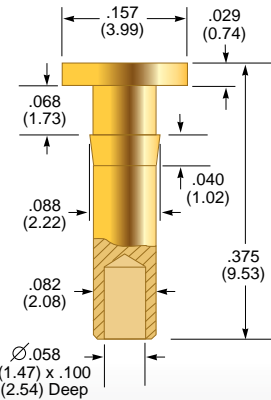

Application GenRad
Material Brass, Gold plated
Hole diameter $\varnothing .085 (2.15)$
Suggested drill #44 or 2.15 mm

DER

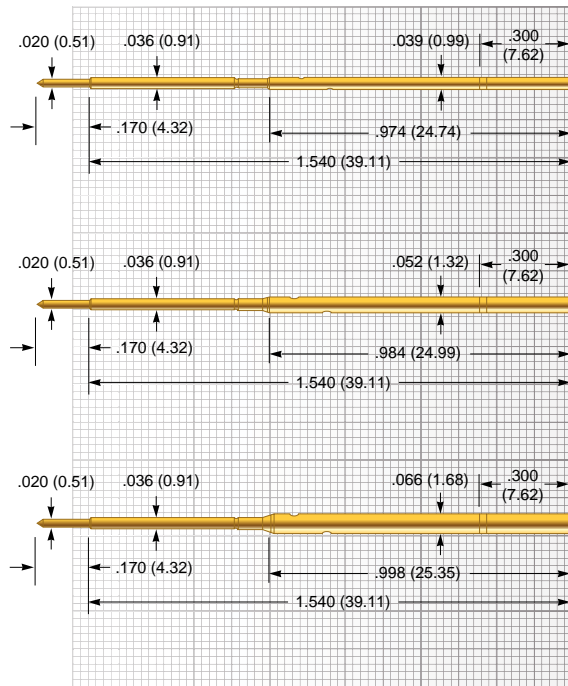

DER-050
50 mil

DER-075
75 mil

DER-100
100 mil

Tip Style

B	J	T				
Ø .020 (0.51)	Ø .020 (0.51)	Ø .020 (0.51)				

Mechanical

Recommended Travel: .130 (3.30)
 Full Travel: .160 (4.06)
 Operating Temperature: -55°C to +150°C

Spring Force in oz. (grams)

	Order Code	Preload	Rec. Travel
Standard	- 3.5	2.62 (74)	3.50 (99)

Electrical (Static Conditions)

Current Rating: 3 amps
 Average Probe Resistance: <15 mOhms

Materials and Finishes

Plunger: Heat-treated BeCu alloy, plated with hard Gold over Nickel
 Barrel: Work-hardened Nickel Silver alloy, plated with hard Gold over Nickel
 Spring: Stainless Steel

DER-050

Hole diameter: Ø .038 to .039 (0.97 to 0.99)
 Suggested drill: #61 or 0.99 mm
 Probes (ordered separately): POGO-62

DER-075

Hole diameter: Ø .053 to .055 (1.35 to 1.40)
 Suggested drill: #54 or 1.40 mm
 Probes (ordered separately): LFRE-1 / POGO-1 LTP-1

DER-100

Hole diameter: Ø .067 to .069 (1.70 to 1.75)
 Suggested drill: #51 or 1.75 mm
 Probes (ordered separately): LFRE-25 / POGO-25 LTP-25

DER Series for wireless fixtures

The DER Series receptacle is used with a replacable POGO, LFRE, LFLT or LTP probe to build a doubled ended probe. ECT offers the DER series in all common used test center spacing.

Example showing receptacle and probe



Dimensions in inches (millimeters). Specifications subject to change without notice. Consult factory for other temperature requirements, and applications below -40°C. Stocking Disclaimer: Stocking levels for part numbers listed in this catalog are subject to change. Availability is based on current levels of usage and demand.



BMP-1 / BMP-1-S / BMP-3

Mechanical

Recommended Travel: .050 (1.27)
 Full Travel: .062 (1.57)
 Direction of Rotation: Counter clock wise
 Scribed Diameter: .050 (1.27)
 Special diameters available.

Spring Force in oz. (grams)

	Preload	Rec. Travel
Standard	4.41 (125)	5.19 (147)

Electrical (Static Conditions)

Current Rating: 50 mA
 Voltage Rating: 15VDC
 Recommended Duty Cycle: 1 sec. On (min.)
 5 sec. Off

Materials and Finishes

Plunger Tip: Carbide
 Receptacle: Stainless Steel

Mounting

BMP-1 / BMP-1-S
 Hole diameter: Ø .468 (11.89)
 Suggested drill: 15/32 (in.) or 11.90 mm
 BMP-3
 Hole diameter: Ø .610 (15.50)
 Suggested drill: 39/64 (in.) or 15.50 mm

Order Number

Board Marker: BMP-1
 BMP-1-S
 BMP-3
 Spare Receptacle: BMR-1
 BMR-3
 Replacement Tip: BMT-1

Tools

Insertion tool for BMR-1: RIT-BMP
 Extraction tool for BMR-1: EXT-BMP

BMP-1

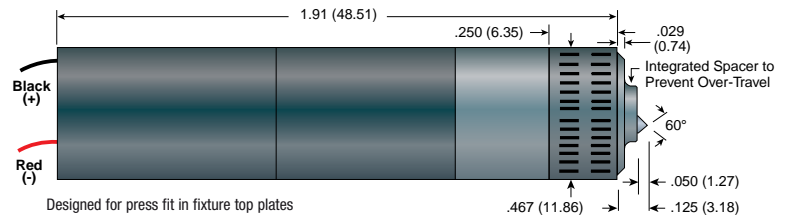

BMP-1-S

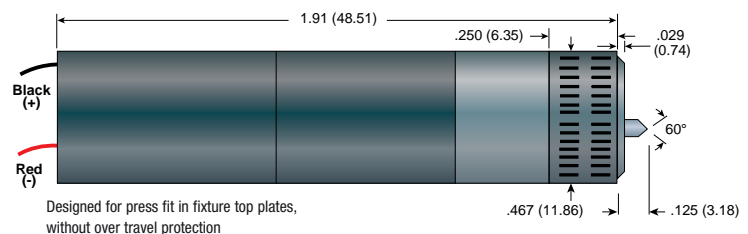

BMP-3

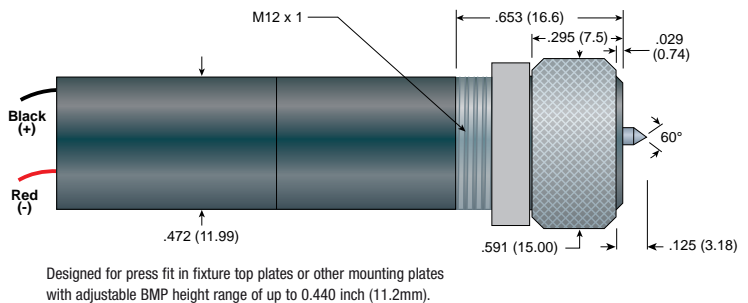

Applications

The BMP Board Marker Probe patented design is for installation on bare board or loaded board test fixtures. When your tester is equipped with the appropriate electronics and software, the BMP scribes a permanent .050" circle on every "passed" PCB or device tested. Boards that fail the test are not marked. The risk of human error is eliminated in PCB testing and sorting.

The unit requires less than .500" of fixture area. It is designed to mark board areas of bare glass (FR4), solder mask over glass or copper, or bare tinned copper.

The BMP includes a mounting receptacle and a motor/transmission assembly. It can be easily removed from the receptacle for use in other fixtures. Spare receptacles and tip replacement assemblies are available. The thread between receptacle and housing is 7/16-20 UNF.

Application Examples

- Bare Board Test
- Loaded Board Test
- Connector / Wire Harness

Benefits

- Hands Free Operation
- No Hazardous Consumables
- Durable
- > 50,000 Cycles before Tip Replacement
- Easy to Fixture

Features

- Permanent Mark
- Controllable Mark Intensity
- Driven by Test Program
- MicroGrain Carbide Tip
- Replaceable Tip

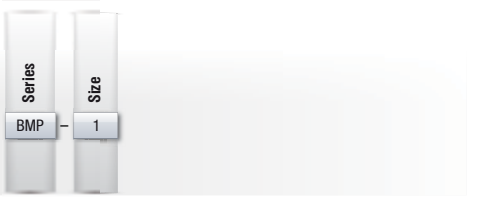

BMP-4

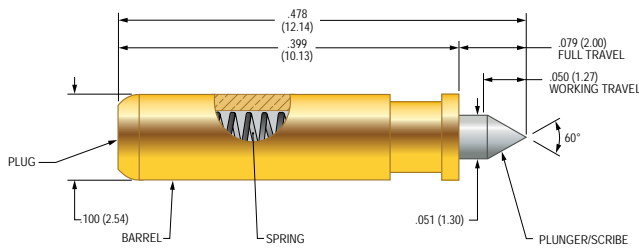
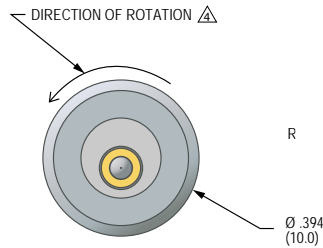
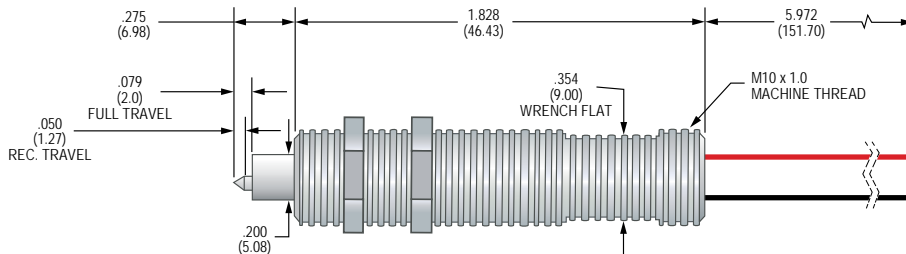

BMT-4

Mechanical

- Recommended Travel: .050 (1.27)
- Full Travel: .079 (2.00)
- Direction of Rotation: Counter clock wise
- Scribed Diameter: .050 (1.27)

Spring Force in oz. (grams)

	Preload	Rec. Travel
Standard	2.43 (68.9)	5.0 (141.7)

Electrical (Static Conditions)

- Current Rating: 20 mA
- Voltage Rating: 12VDC
- Recommended Duty Cycle: 2 sec. On (min.)
3 sec. Off

Materials and Finishes

- Plunger Tip: Carbide
- Receptacle: Stainless Steel

Mounting

- Hole diameter: BMP-4
Ø .398 (10.1)
or M10 x 1.0 threaded hole

Order Number

- Board Marker: BMP-4
- Replacement Tip kit: BMT-4

Mounting Options

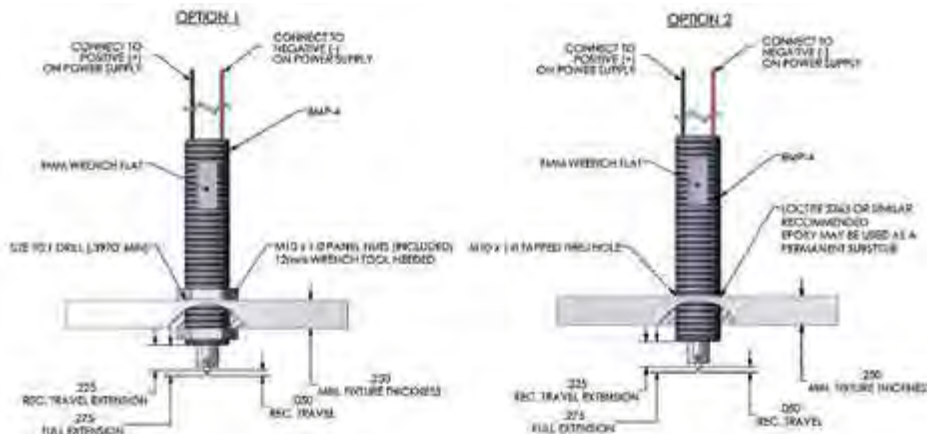

Dimensions in inches (millimeters). Specifications subject to change without notice. Consult factory for other temperature requirements, and applications below -40°C. Stocking Disclaimer: Stocking levels for part numbers listed in this catalog are subject to change. Availability is based on current levels of usage and demand.



BMP-5

Mechanical

Recommended Travel: .050 (1.27)
 Full Travel: .079 (2.00)
 Direction of Rotation: Counter clock wise
 Scribed Diameter: .050 (1.27)

Spring Force in oz. (grams)

	Preload	Rec. Travel
Standard	2.43 (68.9)	5.0 (141.7)

Electrical (Static Conditions)

Current Rating: 20 mA
 Voltage Rating: 12VDC
 Recommended Duty Cycle: 2 sec. On (min.)
 3 sec. Off

Materials and Finishes

Plunger Tip: Carbide
 Receptacle: Stainless Steel

Mounting

Hole diameter: BMP-5
 Ø .472 (12.1)
 or M12 x 1.0 threaded hole

Order Number

Board Marker: BMP-5
 Replacement Tip kit: BMT-4

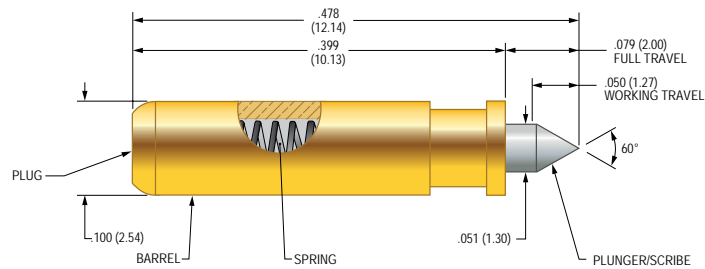
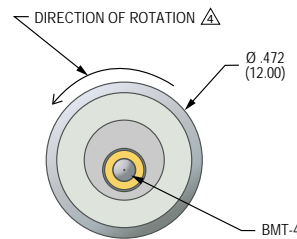
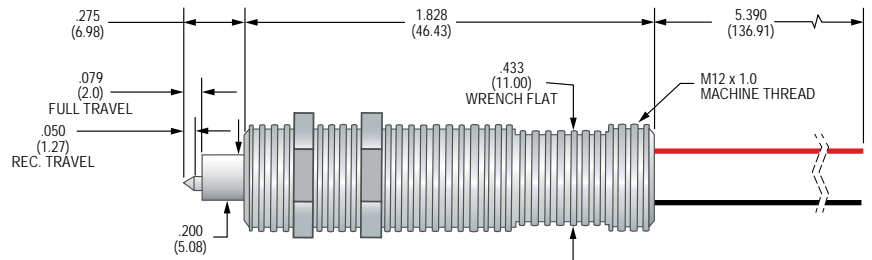

BMT-4

Mounting Options

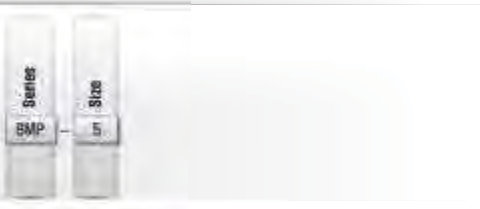
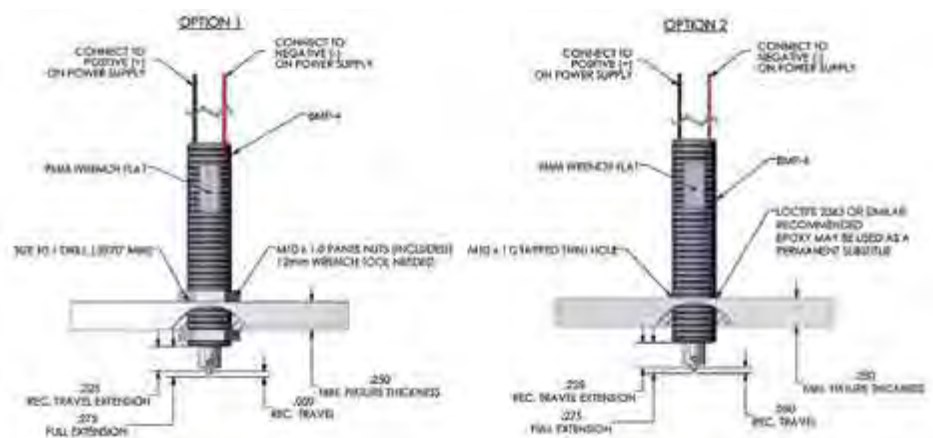

GENERAL PURPOSE - REPLACEABLE PROBES

Replaceable Probes are those designed for typical Automotive and Industrial Board Test and standard continuity test, contacting industry norm test points such as leads, vias and pads.

All of the probes in this section are designed for high volume testing and are replaceable through the use of a mating receptacle mounted into a retaining plate or retaining block via a “press-ring” or knurl.

A replaceable probe is retained by a separate component, the receptacle, which is permanently fixed into a retention plate to which electrical connection is made. Removal of the probe does not damage or break the electrical connection. Typical probe retention is achieved by detents in the receptacle or additionally with a “Pylon” bend in the probe itself to prevent anti walkout.

ECT offers an extensive selection of General Purpose Probes for a wide variety of application in various industries, making ECT spring probes the first choice of test engineers worldwide.

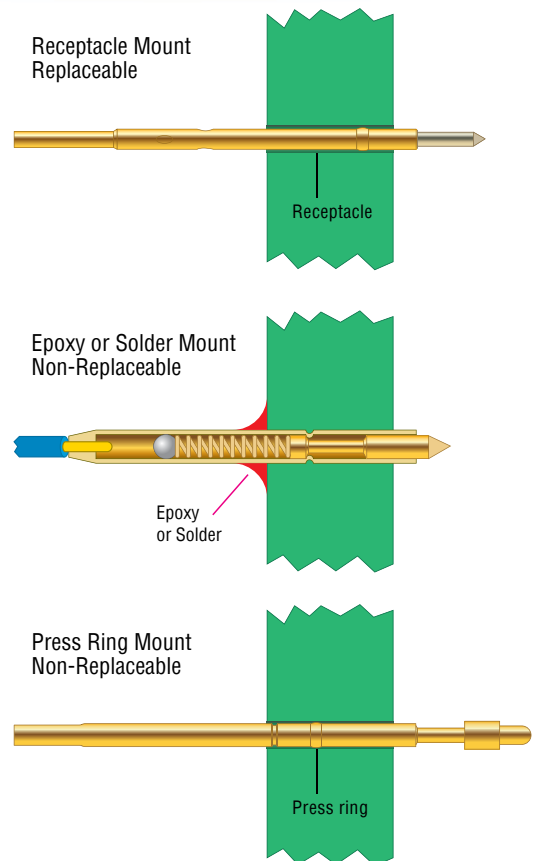

RMP-22B

20 mil (0.51 mm)

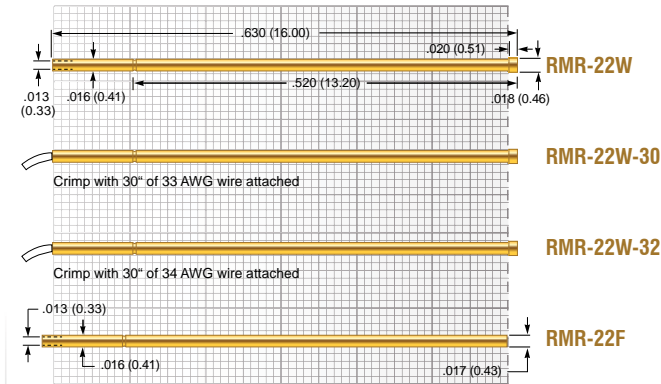
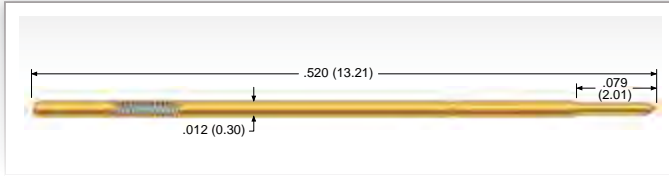

Mechanical

Recommended Travel:	.052 (1.33)
Full Travel:	.079 (2.01)
Operating Temperature:	-55°C to +105°C

Spring Force in oz. (grams)

	Preload	Rec. Travel
Standard	0.51 (14)	1.69 (48)

Electrical (Static Conditions)

Current Rating:	2 amps
Average Probe Resistance:	<125 mOhms

Materials and Finishes

Plunger:	Heat-treated Steel, Nickel Boron plated
Barrel:	BeCu alloy, Gold plated
Spring:	Music Wire, Gold plated

Receptacle

Hole diameter:	Ø .016 to .017 (0.41 to 0.43)
Suggested drill:	#78 or 0.42 mm
Material Housing:	Heat-treated BeCu, Gold plated over hard Nickel

Tip Style

B				
Ø .008 (0.20)				

MEP-30

30 mil (0.76 mm)

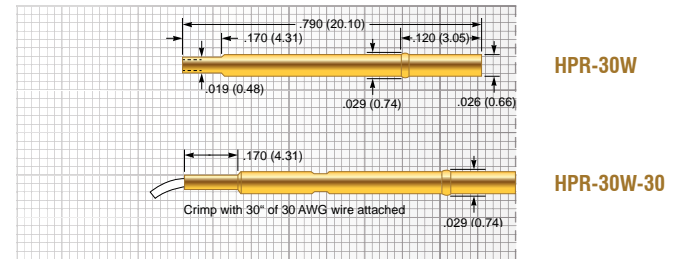

Mechanical

Recommended Travel:	.050 (1.27)
Full Travel:	.075 (1.91)
Operating Temperature:	-55°C to +105°C

Spring Force in oz. (grams)

	Preload	Rec. Travel
Standard	0.39 (11)	1.39 (39)

Electrical (Static Conditions)

Current Rating:	2 amps
Average Probe Resistance:	<50 mOhms

Materials and Finishes

Plunger:	Heat-treated BeCu, Gold plated over hard Nickel
Barrel:	Work hardened BeCu, Gold plated over hard Nickel
Spring:	Music Wire, Gold plated

Receptacle

Hole diameter:	Ø .0265 to .0276 (0.67 to 0.70)
Suggested drill:	#71 or 0.70 mm
Material:	Work hardened BeCu, Gold plated over hard Nickel

Tip Style

B	G	J	U	
Ø .014 (0.36)	Ø .014 (0.36)	Ø .014 (0.36)	Ø .012 (0.30)	

HPA-40

39 mil (1.00 mm)

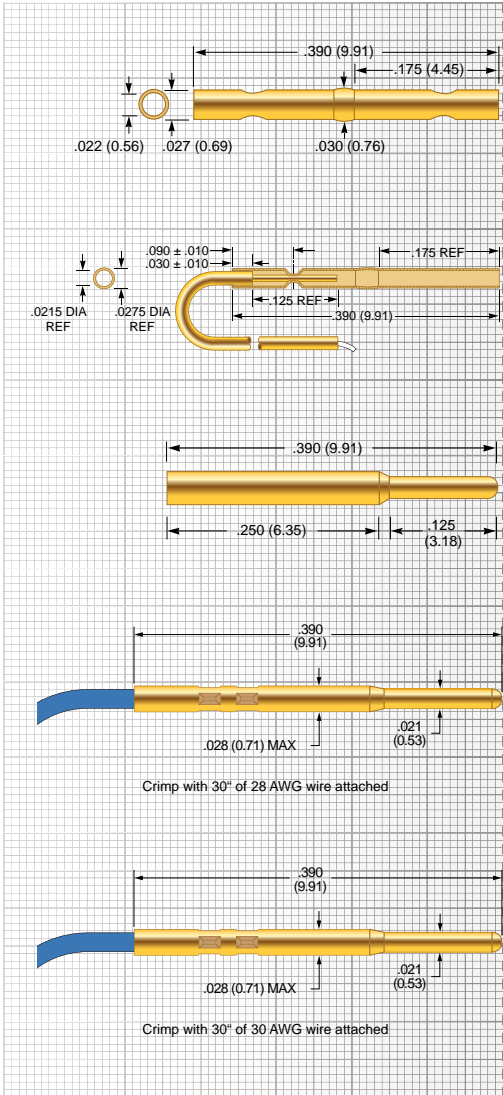
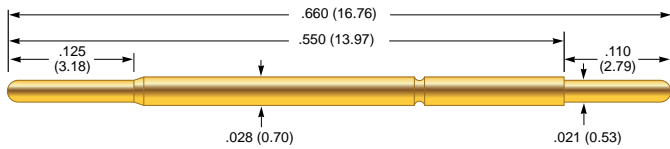

HPR-40W

HPR-40W-30

HPR-40T

HPR-40T-28

HPR-40T-30

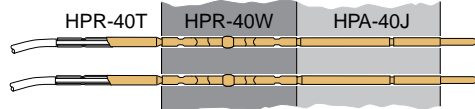

Mechanical

Recommended Travel: .050 (1.27)
 Full Travel: .075 (1.91)
 Operating Temperature: -55°C to +150°C

Spring Force in oz. (grams)

	Preload	Rec. Travel
Standard	0.79 (22)	1.75 (49)

Electrical (Static Conditions)

Current Rating: 2 amps
 Average Probe Resistance: <35 mOhms

Materials and Finishes

Plunger: Heat-treated BeCu, Gold plated over hard Nickel
 Barrel: Work hardened Nickel Silver, Gold plated over hard Nickel
 Spring: Stainless Steel, Silver plated

Receptacle

Hole diameter: Ø .028 (0.70)
 Suggested drill: #70 or 0.70 mm
 Material Housing: Work hardened Nickel Silver, Gold plated over hard Nickel

Tip Style

A	B	C	G	J
Ø .035 (0.89)	Ø .021 (0.53)	Ø .021 (0.53)	Ø .021 (0.53)	Ø .021 (0.53)

Dimensions in inches (millimeters). Specifications subject to change without notice. Consult factory for other temperature requirements, and applications below -40°C. Stocking Disclaimer: Stocking levels for part numbers listed in this catalog are subject to change. Availability is based on current levels of usage and demand.



ECT CONTACT PRODUCTS
 A CoNu Company
 ECT-CPG.com
 shop.ECT-CPG.com

P2662A

50 mil (1.27 mm)

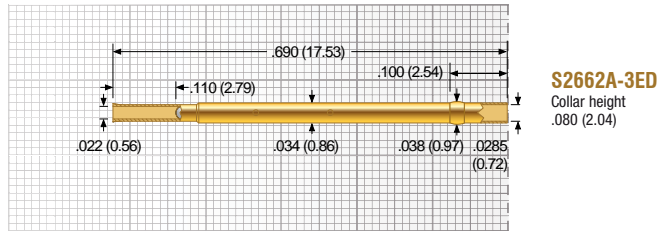
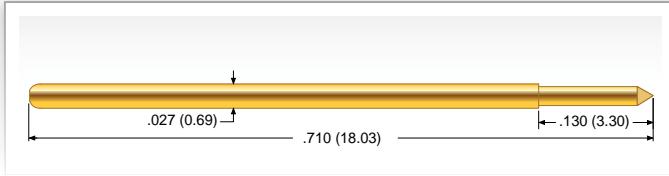

S2662A-3ED
Collar height
.080 (2.04)

Mechanical

Recommended Travel: .067 (1.70)
Full Travel: .090 (2.29)
Operating Temperature: -55°C to +85°C

Spring Force in oz. (grams)

	Order Code	Preload	Rec. Travel
Standard	1	0.70 (20)	1.7 (48)
Alternate	2	0.60 (17)	2.5 (71)

Electrical (Static Conditions)

Current Rating: 3 amps
Average Probe Resistance: <30 mOhms

Materials and Finishes

Plunger: Heat-treated BeCu, Gold plated over hard Nickel
Barrel: Phosphorous Bronze, Gold plated
Spring: BeCu, Silver plated
Ball: Stainless Steel

Receptacle

Hole diameter: Ø .0350 to .0365 (0.89 to 0.93)
Suggested drill: #64 or 0.92 mm
Material Housing: Nickel Silver, Gold plated

Tip Style

1C	1Q	1R	2V
Ø .021 (0.53)	Ø .021 (0.53)	Ø .021 (0.53)	Ø .040 (1.02)
		r = .013 (0.33)	

P2662B

50 mil (1.27 mm)

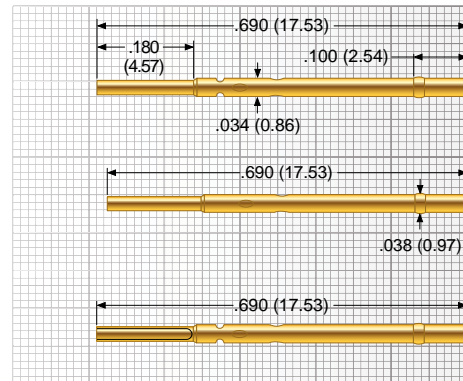
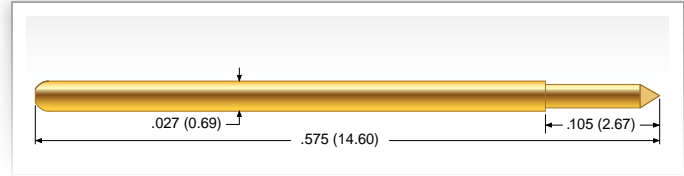

PR261-0
Collar height
= .040 (1.02)

PR261-0F
Flush Mount

PR261-1
Collar height
= .040 (1.02)

PR261-1F
Flush Mount

Mechanical

Recommended Travel: .050 (1.27)
Full Travel: .068 (1.73)
Operating Temperature: -55°C to +85°C

Spring Force in oz. (grams)

	Order Code	Preload	Rec. Travel
Standard	1	1.00 (28)	1.8 (51)
Alternate	2	0.50 (14)	2.5 (71)

Electrical (Static Conditions)

Current Rating: 3 amps
Average Probe Resistance: <30 mOhms

Materials and Finishes

Plunger: Heat-treated BeCu, Gold plated over hard Nickel
Barrel: Phosphorous Bronze, Gold plated
Spring: BeCu, Silver plated
Ball: Stainless Steel

Receptacle

Hole diameter: Ø .0350 to .0365 (0.89 to 0.93)
Suggested drill: #64 or 0.92 mm
Material Housing: Nickel Silver, Gold plated

Tip Style

1C	1Q	1R	2V
Ø .021 (0.53)	Ø .021 (0.53)	Ø .021 (0.53)	Ø .040 (1.02)
		r = .013 (0.33)	

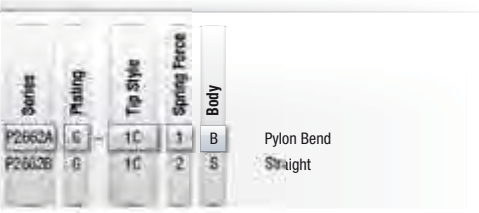

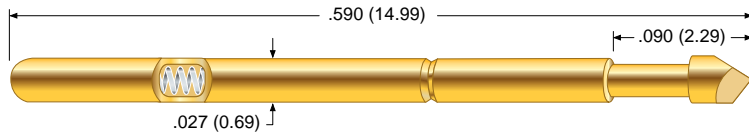

HPA-50
50 mil (1.27 mm)

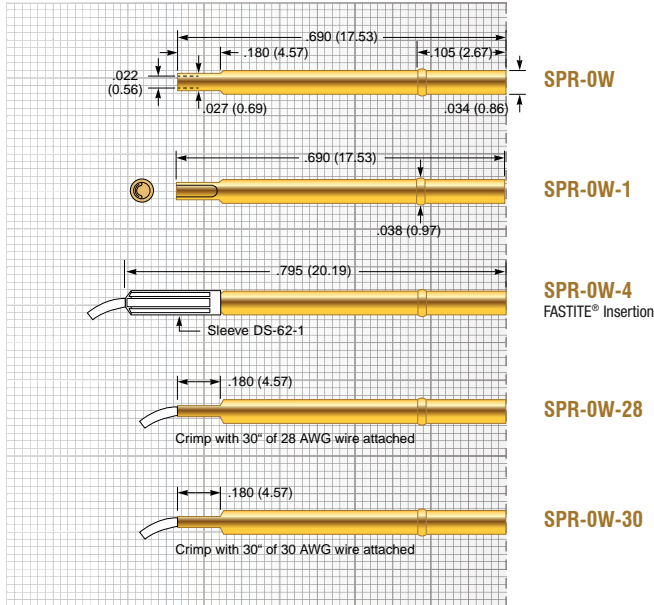

Mechanical

Recommended Travel: .050 (1.27)
Full Travel: .050 (1.27)
Operating Temperature: -55°C to +105°C

Spring Force in oz. (grams)

	Preload	Rec. Travel
Standard	1.55 (44.00)	3.2 (91)

Electrical (Static Conditions)

Current Rating: 3 amps
Average Probe Resistance: <35 mOhms

Materials and Finishes

Plunger: Heat-treated BeCu, Gold plated over hard Nickel
Barrel: Work hardened Phosphor Bronze, Gold plated over hard Nickel
Spring: Music Wire, Gold plated

Receptacle

Hole diameter: Ø .035 to .0365 (0.89 to 0.93)
Suggested drill: #64 or 0.92 mm
Material Housing: Work-hardened Nickel Silver, Gold plated over hard Nickel

Tip Style

B	D	G	T	U		
Ø .021 (0.53)	Ø .035 (0.89)	Ø .021 (0.53)	Ø .035 (0.89)	Ø .018 (0.46)		

Dimensions in inches (millimeters). Specifications subject to change without notice. Consult factory for other temperature requirements, and applications below -40°C. Stocking Disclaimer: Stocking levels for part numbers listed in this catalog are subject to change. Availability is based on current levels of usage and demand.



ECT CONTACT PRODUCTS
A CoNu Company
ECT-CPG.com
shop.ECT-CPG.com



HPA-0 / SPA-0

50 mil (1.27 mm)

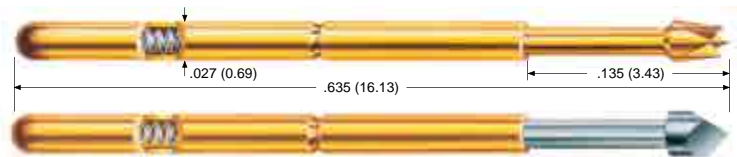

Mechanical

- Recommended Travel: .067 (1.70)
 Full Travel: .100 (2.54)
 Operating Temperature:
 • Standard Spring: -55°C to +150°C
 • Alternate Spring: -55°C to +105°C

Spring Force in oz. (grams)

	Order Code	Preload	Rec. Travel
Standard		0.61 (17)	2.80 (79)
Alternate	- 1	0.78 (22)	3.70 (105)

Electrical (Static Conditions)

- Current Rating: 3 amps
 Average Probe Resistance HPA: < 35 mOhms
 Average Probe Resistance SPA: < 50 mOhms

Materials and Finishes

- Plunger HPA: Heat-treated BeCu, Gold plated over hard Nickel
 Plunger SPA: Heat-treated BeCu, Rhodium plated over hard Nickel
 Barrel: Work hardened Phosphor Bronze, Gold plated over hard Nickel
 Spring:
 • Standard: Stainless Steel, Silver plated
 • Alternate: Music Wire, Silver plated

Receptacle

- Hole diameter: Ø .035 to .0365 (0.89 to 0.93)
 Suggested drill: #64 or 0.92 mm
 Material Housing: Work-hardened Nickel Silver, Gold plated over hard Nickel

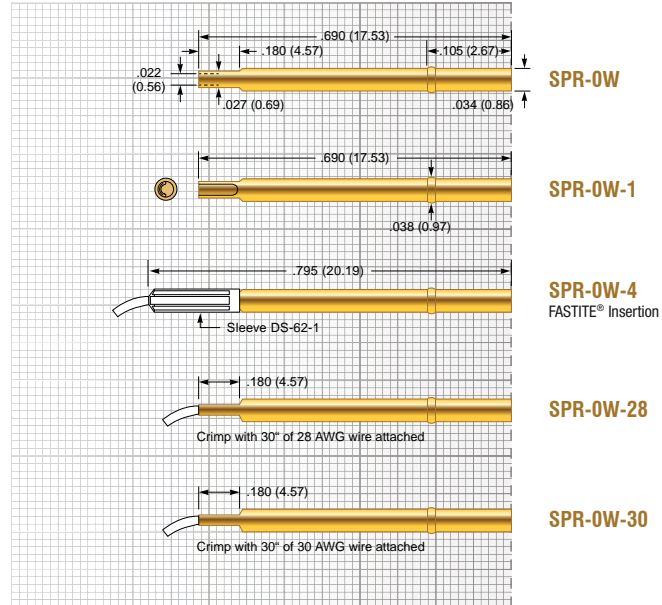

HPA Tip Style

A	B	D	F	G12	G21	H
Ø .035 (0.89)	Ø .021 (0.53)	Ø .035 (0.89)	Ø .035 (0.89)	Ø .012 (0.31)	Ø .021 (0.53)	Ø .035 (0.89)
J	L	T				
Ø .021 (0.53)	Ø .035 (0.89)	Ø .035 (0.89)				

SPA Tip Style

A	B	D	G12	G21	H	J
Ø .035 (0.89)	Ø .021 (0.53)	Ø .035 (0.89)	Ø .012 (0.31)	Ø .021 (0.53)	Ø .035 (0.89)	Ø .021 (0.53)
L	T					
Ø .035 (0.89)	Ø .035 (0.89)					

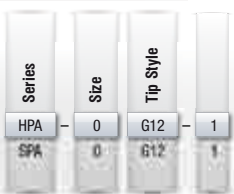

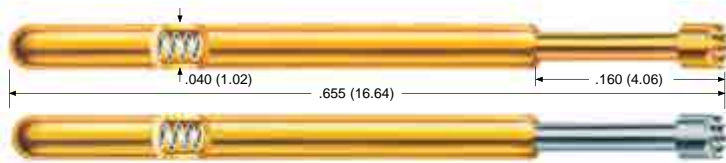

HPA-1 / SPA-1

75 mil (1.91 mm)

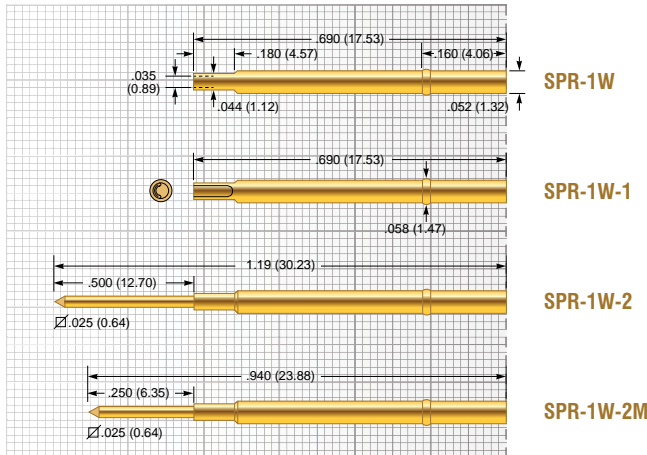

Mechanical

Recommended Travel: .067 (1.70)
 Full Travel: .100 (2.54)
 Operating Temperature: -55°C to +150°C

Spring Force in oz. (grams)

	Order Code	Preload	Rec. Travel
Standard		1.10 (31)	2.5 (71)
Alternate	- 1	1.30 (37)	4.5 (128)

Electrical (Static Conditions)

Current Rating: 3 amps
 Average Probe Resistance HPA: <35 mOhms
 Average Probe Resistance SPA: <50 mOhms

Materials and Finishes

Plunger HPA: Heat-treated BeCu, Gold plated over hard Nickel
 Plunger SPA: Heat-treated BeCu, Rhodium plated over hard Nickel
 Barrel: Work hardened Phosphor Bronze, Gold plated over hard Nickel
 Spring: Stainless Steel, Silver plated

Receptacle

Hole diameter: Ø .053 to .055 (1.35 to 1.40)
 Suggested drill: #54 or 1.40 mm
 Material Housing: Work-hardened Nickel Silver, Gold plated over hard Nickel
 Material Post: Phosphorous Bronze, Gold plated

HPA Tip Style

A	B	C	D	E	F	G
Ø .060 (1.52)	Ø .021 (0.53)	Ø .021 (0.53)	Ø .040 (1.02)	Ø .060 (1.52)	Ø .060 (1.52)	Ø .021 (0.53)
H	J	L	T			
Ø .060 (1.52)	Ø .021 (0.53)	Ø .030 (0.76)	Ø .057 (1.45)			

SPA Tip Style

A	B	C	D	E	F	G
Ø .060 (1.52)	Ø .021 (0.53)	Ø .021 (0.53)	Ø .040 (1.02)	Ø .060 (1.52)	Ø .060 (1.52)	Ø .021 (0.53)
H	J	T				
Ø .060 (1.52)	Ø .021 (0.53)	Ø .057 (1.45)				



Dimensions in inches (millimeters). Specifications subject to change without notice. Consult factory for other temperature requirements, and applications below -40°C. Stocking Disclaimer: Stocking levels for part numbers listed in this catalog are subject to change. Availability is based on current levels of usage and demand.



HPA-52

75 mil (1.91 mm)

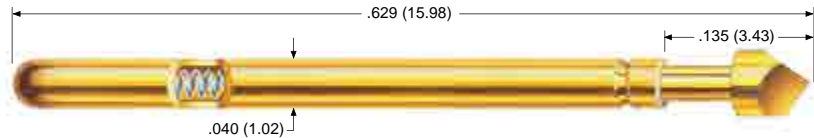

Mechanical

Recommended Travel: .075 (1.91)
 Full Travel: .075 (1.91)
 Operating Temperature: -55°C to +150°C

Spring Force in oz. (grams)

	Order Code	Preload	Rec. Travel
Standard		1.68 (48)	3.22 (91)
Alternate	- 1	2.54 (72)	6.20 (176)

Electrical (Static Conditions)

Current Rating: 3 amps
 Average Probe Resistance: < 15 mOhms

Materials and Finishes

Plunger: Heat-treated BeCu, Gold plated over hard Nickel
 Barrel: Work-hardened Phosphor Bronze, Gold plated over hard Nickel
 Spring: Stainless Steel, Silver plated

Receptacle

Hole diameter: Ø .053 to .055 (1.35 to 1.40)
 Suggested drill: #54 or 1.40 mm
 Material Housing: Work-hardened Nickel Silver, Gold plated over hard Nickel
 Material Post: Phosphorous Bronze, Gold plated

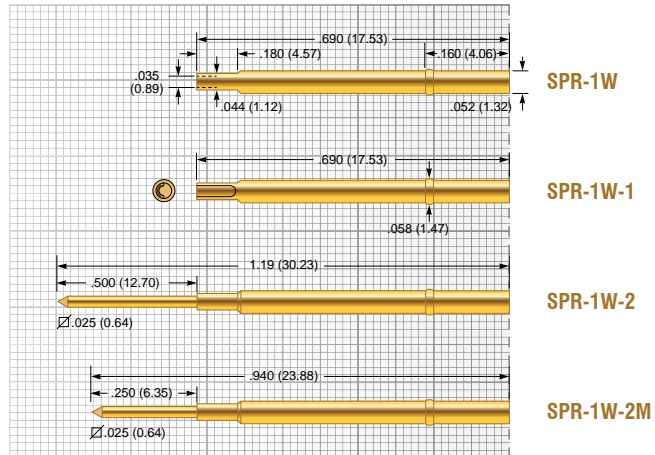

HPA Tip Style

B	D	T				
Ø .021 (0.53)	Ø .040 (1.02)	Ø .057 (1.45)				

Series: HPA | Size: 52 | Tip Style: B



P2663

75 mil (1.91 mm)

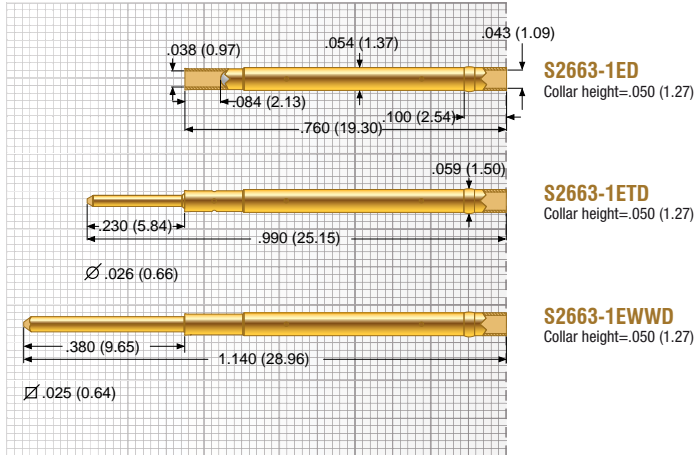
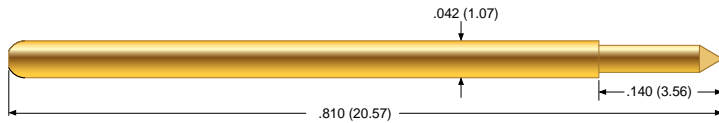

Mechanical

Recommended Travel: .067 (1.70)
 Full Travel: .090 (2.29)
 Operating Temperature: -55°C to +150°C

Spring Force in oz. (grams)

	Order Code	Preload	Rec. Travel
Standard	- 1	1.50 (42)	3.3 (94)
Alternate	- 2	1.00 (28)	2.0 (57)

Electrical (Static Conditions)

Current Rating: 3 amps
 Average Probe Resistance: <10 mOhms

Materials and Finishes

Plunger: Hardened BeCu, Gold plated
 Barrel: Phosphorous Bronze, Gold plated
 Spring: Stainless Steel
 Ball: Stainless Steel

Receptacle

Hole diameter: Ø .0561 to .0576 (1.43 to 1.46)
 Suggested drill: 1.45 mm
 Material Housing: Brass, Gold plated
 Material Post: Phosphorous Bronze, Gold plated

Tip Style					
1C	1P	1R	1V	1W	
Ø .030 (0.76)	Ø .060 (1.52)	Ø .030 (0.76)	Ø .050 (1.27)	Ø .060 (1.52)	
		r = .018 (0.46)			



Dimensions in inches (millimeters). Specifications subject to change without notice. Consult factory for other temperature requirements, and applications below -40°C. Stocking Disclaimer: Stocking levels for part numbers listed in this catalog are subject to change. Availability is based on current levels of usage and demand.

HPA-74

100 mil (2.54 mm)

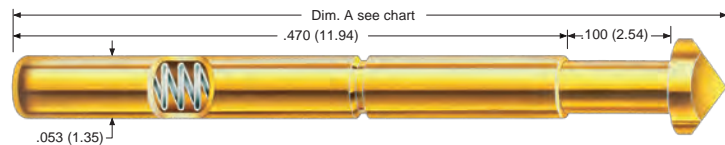

Mechanical

Recommended Travel:	.075 (1.91)
Full Travel:	.100 (2.54)
Operating Temperature	
• Standard Spring:	-55°C to +150°C
• Alternate Spring:	-55°C to +105°C

Spring Force in oz. (grams)

	Order Code	Preload	Rec. Travel
Standard		1.71 (48)	3.0 (85)
Alternate	- 1	2.82 (80)	5.0 (141)

Electrical (Static Conditions)

Current Rating:	3 amps
Average Probe Resistance:	< 35 mOhms

Materials and Finishes

Plunger:	Heat-treated BeCu, Gold plated over hard Nickel
Barrel:	Work hardened Phosphor Bronze, Gold plated over hard Nickel
Spring	
• Standard:	Stainless Steel, Silver plated
• Alternate:	Music Wire, Silver plated

Probe Overall Length

Model No.	Overall Length (Dim. A)
HPA-74A, B	.598 (15.19)
HPA-74C	.586 (14.88)
HPA-74E, T135, T156 HPA-74T65, T80	.610 (15.49)
HPA-74T75	.620 (15.75)

Receptacle

Hole diameter:	Ø .067 to .069 (1.70 to 1.75)
Suggested drill:	#51 or 1.70 mm
Material:	Nickel Silver alloy

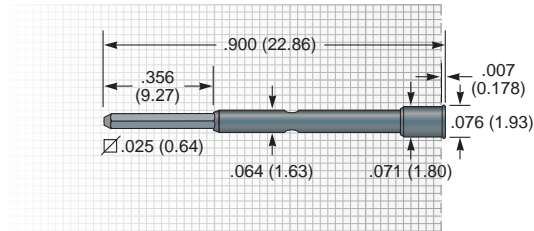

EPR-74W-2

HPA Tip Style

A	B	C	E	T65	T75
Ø .080 (2.03)	Ø .041 (1.04)	Ø .041 (1.04)	Ø .080 (2.03)	Ø .065 (1.65)	Ø .075 (1.91)
T80	T135	T156			
Ø .080 (2.03)	Ø .135 (3.43)	Ø .156 (3.96)			

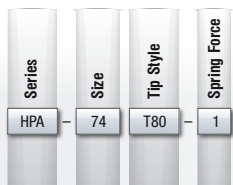

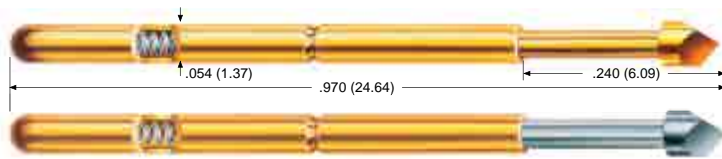

EPA-2 / SPA-2

100 mil (2.54 mm)

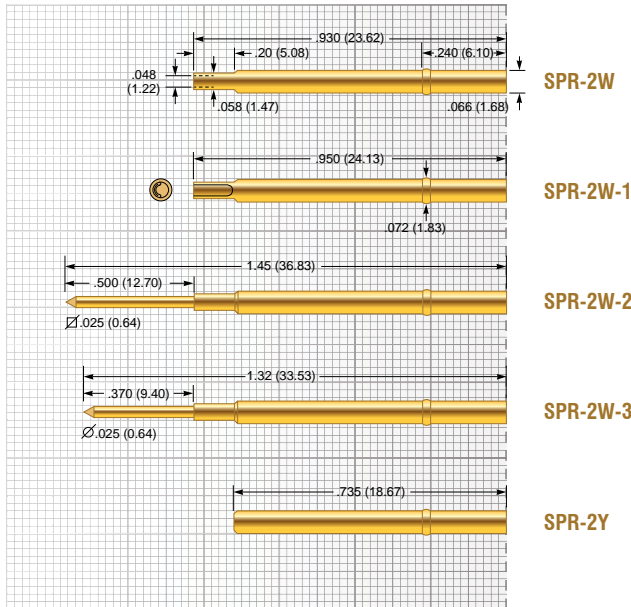

Mechanical

Recommended Travel:	.107 (2.72)
Full Travel:	.160 (4.06)
Operating Temperature:	-55°C to +105°C

Spring Force in oz. (grams)

	Order Code	Preload	Rec. Travel
Standard		1.08 (31)	3.5 (99)
Alternate	- 1	2.64 (75)	6.5 (184)
Ultra High	- 2	4.09 (116)	10.0 (283)

Electrical (Static Conditions)

Current Rating:	5 amps
Average Probe Resistance EPA:	< 35 mOhms
Average Probe Resistance SPA:	< 50 mOhms

Materials and Finishes

Plunger EPA:	Heat-treated BeCu, Gold plated over hard Nickel
Plunger SPA:	Heat-treated BeCu, Rhodium plated over hard Nickel
Barrel:	Work hardened Nickel Silver, Gold plated over hard Nickel
Spring:	Music Wire, Silver plated
Ball:	Stainless Steel, Gold plated

Receptacle

Hole diameter:	Ø .067 to .069 (1.70 to 1.75)
Suggested drill:	#51 or 1.70 mm
Material Housing:	Work-hardened Nickel Silver, Gold plated over hard Nickel
Material Post:	Phosphorous Bronze, Gold plated

EPA / SPA Tip Style

A	B30	B40	C30	C40	D	E
Ø .075 (1.91)	Ø .030 (0.76)	Ø .040 (1.02)	Ø .030 (0.76)	Ø .040 (1.02)	Ø .050 (1.27)	Ø .075 (1.91)
F	G30	G40	H	J30	J40	L
Ø .075 (1.91)	Ø .030 (0.76)	Ø .040 (1.02)	Ø .075 (1.91)	Ø .030 (0.76)	Ø .040 (1.02)	Ø .050 (1.27)
P	T	X				
Ø .075 (1.91)	Ø .075 (1.91)	Ø .050 (1.27)				

Dimensions in inches (millimeters). Specifications subject to change without notice. Consult factory for other temperature requirements, and applications below -40°C. Stocking Disclaimer: Stocking levels for part numbers listed in this catalog are subject to change. Availability is based on current levels of usage and demand.

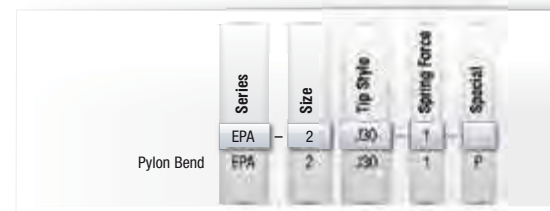

P2664

100 mil (2.54 mm)

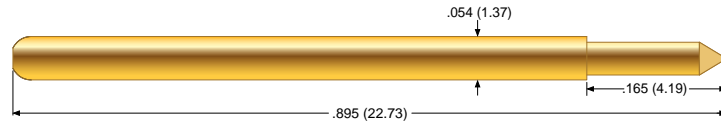

Mechanical

Recommended Travel: .084 (2.13)
 Full Travel: .114 (2.90)
 Operating Temperature: -55°C to +150°C

Spring Force in oz. (grams)

	Order Code	Preload	Rec. Travel
Standard	1	2.00 (57)	3.6 (102)
Alternate	2	3.00 (85)	5.7 (162)

Electrical (Static Conditions)

Current Rating: 5 amps
 Average Probe Resistance: <10 mOhms

Materials and Finishes

Plunger: Heat-treated BeCu, Gold plated over hard Nickel
 Barrel: Phosphorous Bronze, Gold plated
 Spring: Stainless Steel
 Ball: Stainless Steel

Probe Overall Length

Model No.	Overall Length (Dim. A)	Plunger Extension (Dim. B)
P2664G-...	.895 (22.73)	0.165 (4.19)
P2664G-1C...	.845 (21.46)	0.115 (2.92)
P2664G-2R...	.935 (23.75)	0.205 (5.21)

Receptacle

Hole diameter: Ø .069 (1.75)
 Suggested drill: 1.75 mm
 Material Housing: Nickel Silver, Gold plated
 Material Post: Phosphorous Bronze, Gold plated

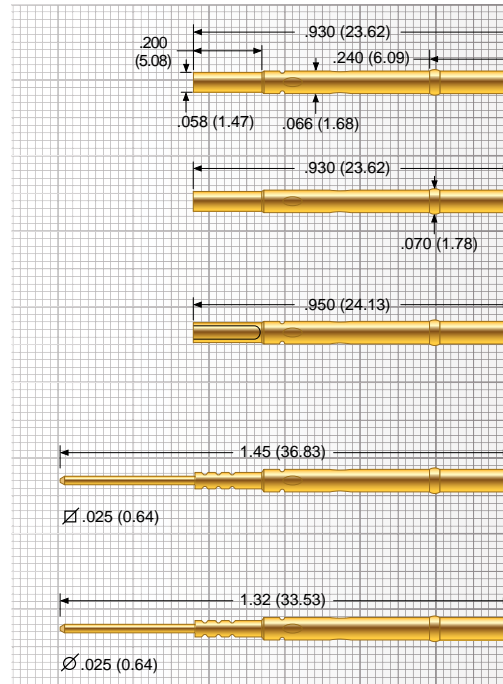

PR541-0
Collar height=.060 (1.52)

PR541-0F
Flush Mount

PR541-1
Collar height=.060 (1.52)

PR541-1F
Flush Mount

PR541-2
Collar height=.060 (1.52)

PR541-2F
Flush Mount

PR541-3
Collar height=.060 (1.52)

PR541-3F
Flush Mount

Tip Style

1C	1R	2R	4V	1W		
Ø .040 (1.02)	Ø .040 (1.02)	Ø .050 (1.27)	Ø .070 (1.78)	Ø .070 (1.78)		
	r=.023 (0.58)	r=.029 (0.74)				



P3158

100 mil (2.54 mm)

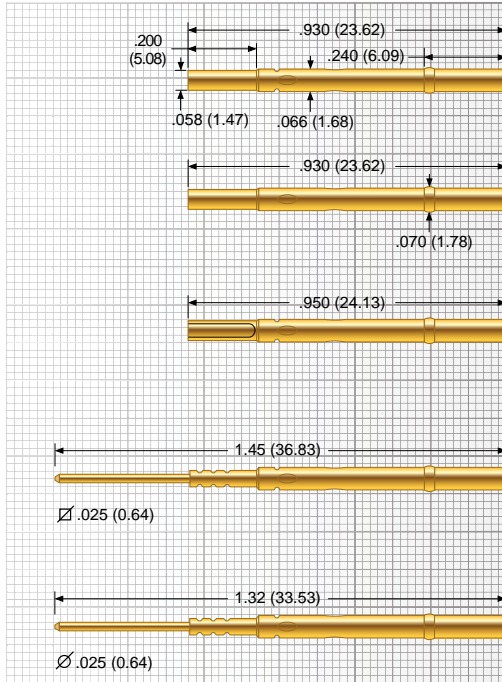
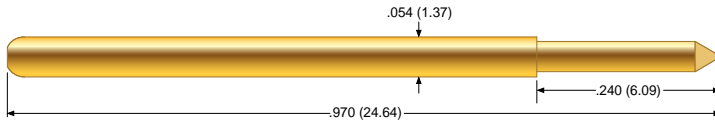

Mechanical

Recommended Travel: .114 (2.90)
 Full Travel: .170 (4.32)
 Operating Temperature: -55°C to +105°C

Spring Force in oz. (grams)

	Order Code	Preload	Rec. Travel
Standard	1	2.70 (77)	6.9 (196)
Alternate	2	1.30 (37)	2.8 (79)

Electrical (Static Conditions)

Current Rating: 8 amps
 Average Probe Resistance: <10 mOhms

Materials and Finishes

Plunger: Heat-treated Steel or BeCu, Gold plated over hard Nickel
 Barrel: Phosphorous Bronze, Gold plated
 Spring: Music Wire
 Ball: Stainless Steel

Receptacle

Hole diameter: $\varnothing .069$ (1.75)
 Suggested drill: 1.75 mm
 Material Housing: Nickel Silver, Gold plated
 Material Post: Phosphorous Bronze, Gold plated

Tip Style

3C	1R	1Q	2Q	1V	1W
$\varnothing .040$ (1.02)	$\varnothing .040$ (1.02)	$\varnothing .060$ (1.52)	$\varnothing .025$ (0.64)	$\varnothing .070$ (1.78)	$\varnothing .070$ (1.78)



Dimensions in inches (millimeters). Specifications subject to change without notice. Consult factory for other temperature requirements, and applications below -40°C. Stocking Disclaimer: Stocking levels for part numbers listed in this catalog are subject to change. Availability is based on current levels of usage and demand.

P5160

100 mil (2.54 mm)

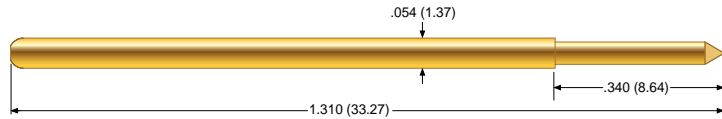

Mechanical

Recommended Travel: .167 (4.24)
 Full Travel: .230 (5.84)
 Operating Temperature: -55°C to +105°C

Spring Force in oz. (grams)

	Order Code	Preload	Rec. Travel
Standard	1	2.50 (71)	6.5 (184)
Alternate	2	1.70 (48)	3.5 (99)
Elevated	3	2.50 (71)	8.2 (232)

Electrical (Static Conditions)

Current Rating: 8 amps
 Average Probe Resistance: < 10 mOhms

Materials and Finishes

Plunger: Hardened Steel or BeCu, Gold plated over hard Nickel
 Barrel: Phosphorous Bronze, Gold plated
 Spring: Music Wire
 Ball: Stainless Steel

Receptacle

Hole diameter: Ø .069 (1.75)
 Suggested drill: 1.75 mm
 Material Housing: Nickel Silver, Gold plated
 Material Post: Phosphorous Bronze, Gold plated

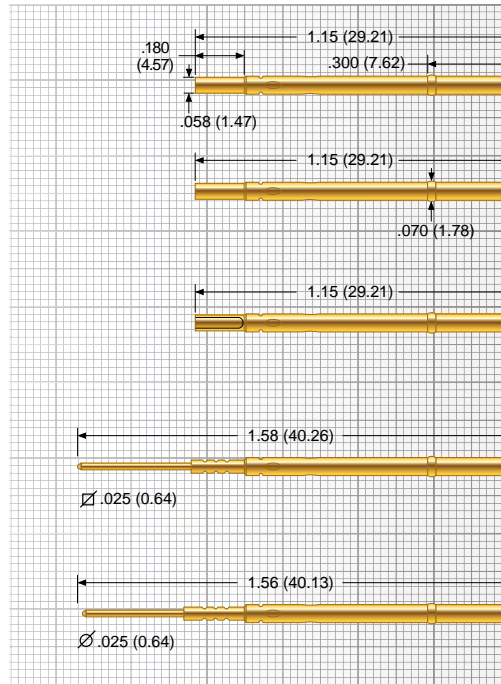

PR54-0
Collar height=.030 (.762)

PR54-0F
Flush Mount

PR54-1
Collar height=.030 (.762)

PR54-1F
Flush Mount

PR54-2
Collar height=.030 (.762)

PR54-2F
Flush Mount

PR54-3
Collar height=.030 (.762)

PR54-3F
Flush Mount

Tip Style

2C	3C	1R	3P	1Q	1V	2W
Ø .040 (1.02)	Ø .040 (1.02)	Ø .030 (0.76)	Ø .060 (1.52)	Ø .060 (1.52)	Ø .060 (1.52)	Ø .060 (1.52)
	Steel	r=.018 (0.46)				

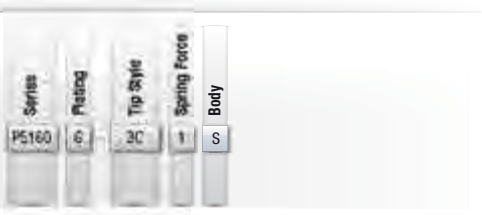

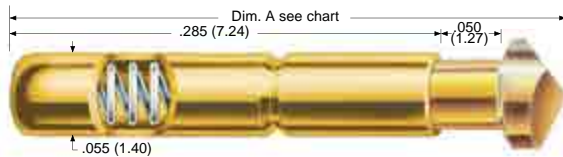

HPA-64 / SPA-64

100 mil (2.54 mm)

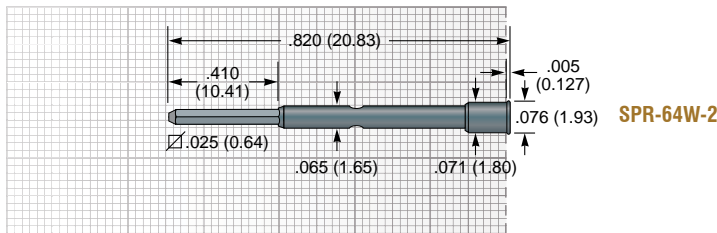

Mechanical

Recommended Travel: .050 (1.27)
 Full Travel: .050 (1.27)
 Operating Temperature: -55°C to +150°C

Spring Force in oz. (grams)

	Preload	Rec. Travel
Standard	1.10 (31)	3.85 (109)

Electrical (Static Conditions)

Current Rating: 3 amps
 Average Probe Resistance HPA / SPA: < 50 mOhms

Materials and Finishes

Plunger: Heat-treated BeCu, Gold plated over hard Nickel
 Barrel HPA: Work hardened Nickel Silver, Gold plated over hard Nickel
 Barrel SPA: Work hardened Nickel Silver
 Spring: Stainless Steel, Silver plated

Probe Overall Length

Model No.	Overall Length (Dim. A)
HPA/SPA-64-1, -4, -7	.375 (9.53)
HPA/SPA-64-2, -3	.365 (9.27)
HPA/SPA-64-8	.385 (9.78)
SPA-64-9, -10	.363 (9.22)
HPA-64-9, -10	.365 (9.27)

Receptacle

Hole diameter: Ø .067 to .069 (1.70 to 1.75)
 Suggested drill: #51 or 1.70 mm
 Material: Nickel Silver alloy

HPA / SPA Tip Style					
-1 Ø .077 (1.96)	-2 Ø .077 (1.96)	-3 Ø .077 (1.96)	-4 Ø .065 (1.65)	-7 Ø .156 (3.96)	-8 Ø .075 (1.99)
-9 Ø .047 (1.19)	-10 Ø .047 (1.19)				



Dimensions in inches (millimeters). Specifications subject to change without notice. Consult factory for other temperature requirements, and applications below -40°C. Stocking Disclaimer: Stocking levels for part numbers listed in this catalog are subject to change. Availability is based on current levels of usage and demand.



P2665

125 mil (3.18 mm)

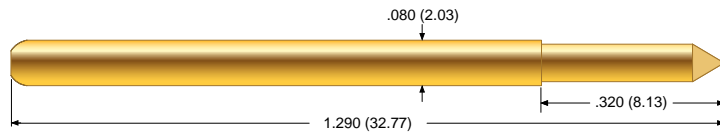

Mechanical

Recommended Travel: .167 (4.24)
 Full Travel: .230 (5.84)
 Operating Temperature: -55°C to +150°C

Spring Force in oz. (grams)

	Order Code	Preload	Rec. Travel
Standard	1	1.50 (43)	3.0 (85)
Alternate	2	2.50 (71)	5.8 (164)

Electrical (Static Conditions)

Current Rating: 15 amps
 Average Probe Resistance: < 10 mOhms

Materials and Finishes

Plunger: Heat-treated BeCu, Gold plated over hard Nickel
 Barrel: Phosphorous Bronze, Gold plated
 Spring: Stainless Steel
 Ball: Stainless Steel

Probe Overall Length

Model No.	Overall Length (Dim. A)	Plunger Extension (Dim. B)
P2665G-...	1.29 (32.77)	0.320 (8.13)
P2665G-2W	1.27 (32.26)	0.300 (7.62)

Receptacle

Hole diameter: Ø .094 to .096 (2.39 to 2.44)
 Suggested drill: #41 or 2.40 mm
 Material Housing: Nickel Silver, Gold plated
 Material Post: Phosphorous Bronze, Gold plated

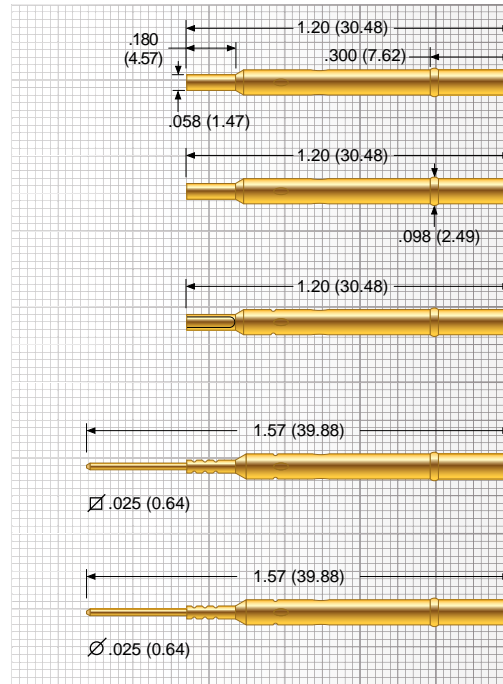

- PR80-0**
Collar height = .090 (2.29)
- PR80-0F**
Flush Mount
- PR80-1F**
Flush Mount
- PR80-1**
Collar height = .090 (2.29)
- PR80-2F**
Flush Mount
- PR80-2**
Collar height = .090 (2.29)
- PR80-3F**
Flush Mount
- PR80-3**
Collar height = .090 (2.29)

Tip Style

1C	1R	1V	1W	2W		
Ø .066 (1.68)	Ø .066 (1.68)	Ø .090 (2.29)	Ø .090 (2.29)	Ø .153 (3.89)		
	r = .036 (0.91)					



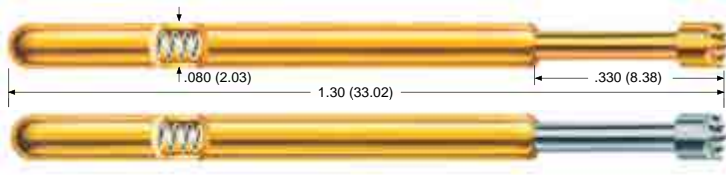

EPA-3 / SPA-3
125 mil (3.18 mm)

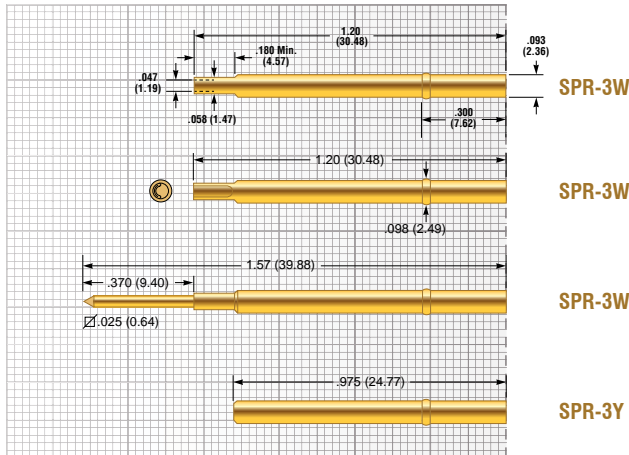

Mechanical

Recommended Travel:	.167 (4.24)
Full Travel:	.250 (6.35)
Operating Temperature	
• Standard Spring:	-55°C to +85°C
• Alternate Spring:	-55°C to +150°C
• Ultra High Spring:	-55°C to +150°C

Spring Force in oz. (grams)

	Order Code	Preload	Rec. Travel
Standard		1.60 (45)	4.5 (128)
Alternate	- 1	2.52 (71)	6.5 (184)
Ultra High	- 2	4.18 (119)	11.7 (332)

Electrical (Static Conditions)

Current Rating:	6 amps
Average Probe Resistance EPA:	< 35 mOhms
Average Probe Resistance SPA:	< 50 mOhms

Materials and Finishes

Plunger EPA:	Heat-treated BeCu, Gold plated over hard Nickel
Plunger SPA:	Heat-treated BeCu, Rhodium plated over hard Nickel
Barrel:	Work hardened Nickel Silver, Gold plated over hard Nickel
Spring	
Standard:	BeCu, Silver plated
Alternate:	Stainless Steel, Silver plated
Ultra High:	Stainless Steel
Ball:	Brass, Gold plated

Receptacle

Hole diameter:	Ø .094 to .096 (2.39 to 2.44)
Suggested drill:	#41 or 2.40 mm
Material Housing:	Work-hardened Nickel Silver, Gold plated over hard Nickel
Material Post:	Phosphorous Bronze, Gold plated

Special

A "P" at the end of the part number in the "Special" field indicates the end of the barrel will have a slight bulge and is used with receptacles lacking detents.



EPA Tip Style						
A	B	C	D	E	F	G
Ø .100 (2.54)	Ø .050 (1.27)	Ø .050 (1.27)	Ø .062 (1.58)	Ø .100 (2.54)	Ø .100 (2.54)	Ø .050 (1.27)
H	J	T				
Ø .100 (2.54)	Ø .050 (1.27)	Ø .100 (2.54)				

SPA Tip Style						
A	B	C	D	E	F	G
Ø .100 (2.54)	Ø .050 (1.27)	Ø .050 (1.27)	Ø .062 (1.58)	Ø .100 (2.54)	Ø .100 (2.54)	Ø .050 (1.27)
H	J	T				
Ø .100 (2.54)	Ø .050 (1.27)	Ø .100 (2.54)				

Dimensions in inches (millimeters). Specifications subject to change without notice. Consult factory for other temperature requirements, and applications below -40°C. Stocking Disclaimer: Stocking levels for part numbers listed in this catalog are subject to change. Availability is based on current levels of usage and demand.



EPA-4 / SPA-4

187 mil (4.75 mm)

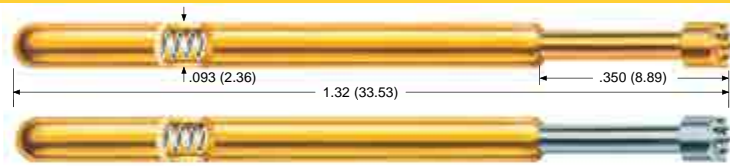

Mechanical

Recommended Travel:	.167 (4.24)
Full Travel:	.250 (6.35)
Operating Temperature	
• Standard Spring:	-55°C to +85°C
• Alternate Spring:	-55°C to +150°C
• Ultra High Spring:	-55°C to +150°C

Spring Force in oz. (grams)

	Order Code	Preload	Rec. Travel
Standard		2.20 (62)	4.8 (136)
Alternate	- 1	3.20 (90)	6.9 (196)
Ultra High	- 2	6.70 (190)	11.8 (335)

Electrical (Static Conditions)

Current Rating:	7 amps
Average Probe Resistance EPA:	< 35 mOhms
Average Probe Resistance SPA:	< 50 mOhms

Materials and Finishes

Plunger EPA:	Heat-treated BeCu, Gold plated over hard Nickel
Plunger SPA:	Heat-treated BeCu, Rhodium plated over hard Nickel
Barrel:	Work hardened Nickel Silver, Gold plated over hard Nickel
Spring	
• Standard:	BeCu, Silver plated
• Alternate:	Stainless Steel, Silver plated
• Ultra High:	Stainless Steel
Ball:	Brass, Gold plated

Receptacle

Hole diameter:	Ø .107 to .109 (2.72 to 2.77)
Suggested drill:	2.75 mm
Material Housing:	Work-hardened Nickel Silver, Gold plated over hard Nickel
Material Post:	Phosphorous Bronze, Gold plated

Special

A "P" at the end of the part number in the "Special" field indicates the end of the barrel will have a slight bulge and is used with receptacles lacking detents.

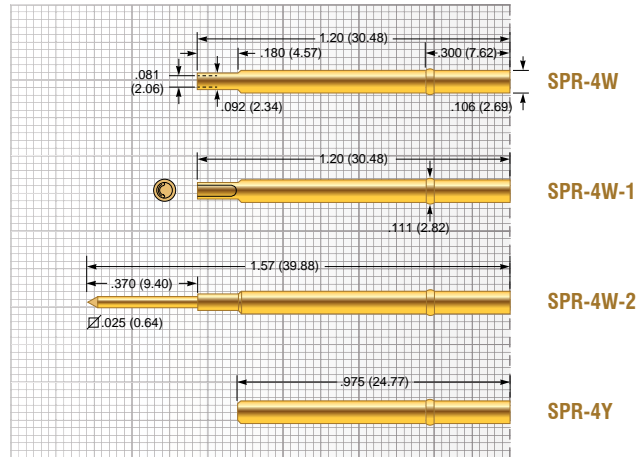

EPA Tip Style

A	B	C	D	E	F	G
Ø .156 (3.96)	Ø .060 (1.53)	Ø .060 (1.53)	Ø .093 (2.36)	Ø .156 (3.96)	Ø .156 (3.96)	Ø .060 (1.53)
H	J					
Ø .156 (3.96)	Ø .060 (1.53)					

SPA Tip Style

A	B	C	D	E	F	G
Ø .156 (3.96)	Ø .060 (1.53)	Ø .060 (1.53)	Ø .093 (2.36)	Ø .156 (3.96)	Ø .156 (3.96)	Ø .060 (1.53)
H	J					
Ø .156 (3.96)	Ø .060 (1.53)					



P2757

187 mil (4.75 mm)

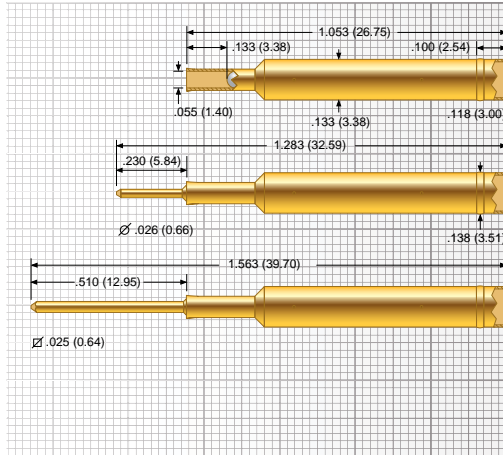
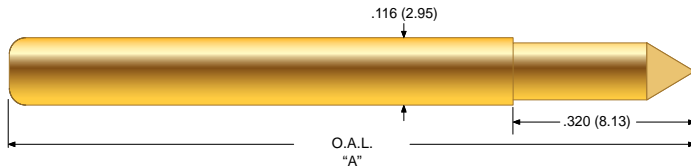

S2757-2ED
Collar height = .090 (2.29)

S2757-2ETD
Collar height = .090 (2.29)

S2757-2EWWD
Collar height = .090 (2.29)

Mechanical

Recommended Travel: .167 (4.24)
Full Travel: .230 (5.84)
Operating Temperature: -55°C to +150°C

Spring Force in oz. (grams)

	Order Code	Preload	Rec. Travel
Standard	1	2.00 (57)	4.0 (113)
Alternate	2	3.50 (99)	6.9 (194)

Electrical (Static Conditions)

Current Rating: 20 amps
Average Probe Resistance: <10 mOhms

Materials and Finishes

Plunger: Heat-treated BeCu, Gold or Silver plated over hard Nickel
Barrel: Phosphorous Bronze, Gold plated
Spring: Stainless Steel
Ball: Stainless Steel

Probe Overall Length

Model No.	Overall Length (Dim. A)
P2757G-...	1.210 (30.73)
P2757G-1W...	1.205 (30.61)
P2757G-2W...	1.205 (30.61)

Receptacle

Hole diameter: Ø .1350 to .1365 (3.43 to 3.47)
Suggested drill: #29 or 3.45 mm
Material Housing: Brass, Gold plated
Material Post: Phosphorous Bronze, Gold plated

Tip Style						
1C	1R	1V	1W	2W	3W	
Ø .098 (2.49)	Ø .120 (3.05)	Ø .152 (3.86)	Ø .154 (3.91)	Ø .250 (6.35)	Ø .122 (3.10)	



Dimensions in inches (millimeters). Specifications subject to change without notice. Consult factory for other temperature requirements, and applications below -40°C. Stocking Disclaimer: Stocking levels for part numbers listed in this catalog are subject to change. Availability is based on current levels of usage and demand.



EPA-5 / SPA-5

187 mil (4.75 mm)

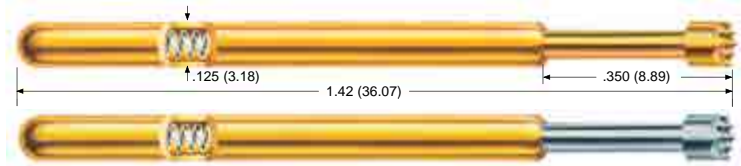

Mechanical

Recommended Travel:	.167 (4.24)
Full Travel:	.250 (6.35)
Operating Temperature	
• Light Spring:	-55°C to +85°C
• Standard Spring:	-55°C to +150°C
• Ultra High Spring:	-55°C to +105°C

Spring Force in oz. (grams)

	Order Code	Preload	Rec. Travel
Light	- 1*	1.96 (56)	3.5 (99)
Standard		6.13 (174)	16.0 (454)
Ultra High	- 2	12.90 (366)	48.0 (1361)

* Available ONLY in SPA-5

Electrical (Static Conditions)

Current Rating:	8 amps
Average Probe Resistance EPA:	< 35 mOhms
Average Probe Resistance SPA:	< 50 mOhms

Materials and Finishes

Plunger EPA:	Heat-treated BeCu, Gold plated over hard Nickel
Plunger SPA:	Heat-treated BeCu, Rhodium plated over hard Nickel
Barrel:	Work hardened Nickel Silver, Gold plated over hard Nickel
Spring	
• Light:	BeCu, Silver plated
• Standard:	Stainless Steel, Silver plated
• Ultra High:	Music Wire, Silver plated
Ball:	Brass, Gold plated

Receptacle

Hole diameter:	Ø .141 to .143 (3.58 to 3.63)
Suggested drill:	3.60 mm
Material Housing:	Work-hardened Nickel Silver, Gold plated over hard Nickel

Special

A "P" at the end of the part number in the "Special" field indicates the end of the barrel will have a slight bulge and is used with receptacles lacking detents.

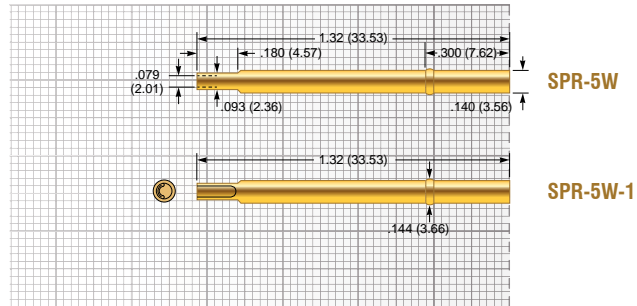

EPA Tip Style

A	B	E	H			
Ø .156 (3.96)	Ø .080 (2.03)	Ø .156 (3.96)	Ø .156 (3.96)			

SPA Tip Style

A	B	H				
Ø .156 (3.96)	Ø .080 (2.03)	Ø .156 (3.96)				

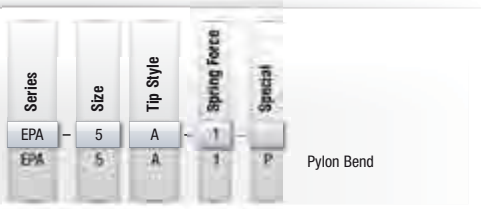

SPP-25

100 mil (2.54 mm)

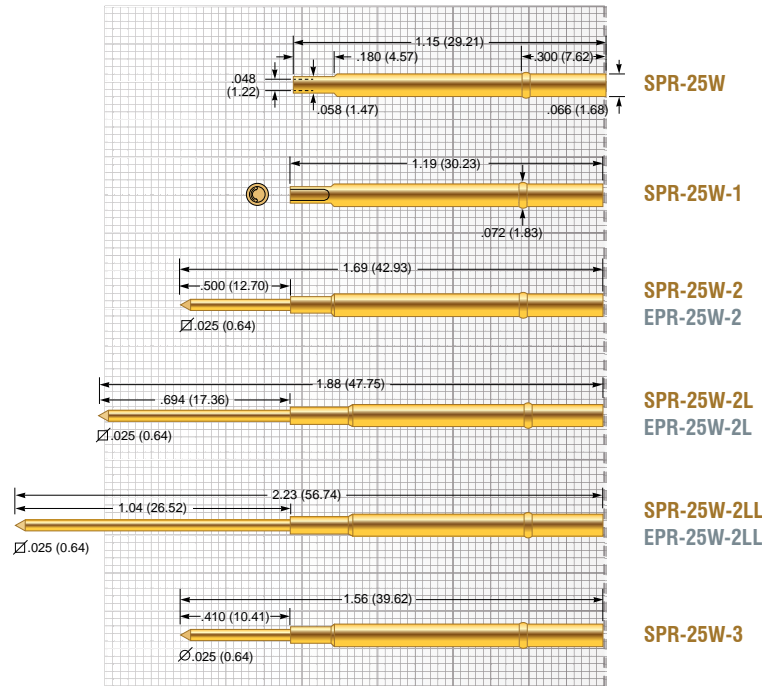
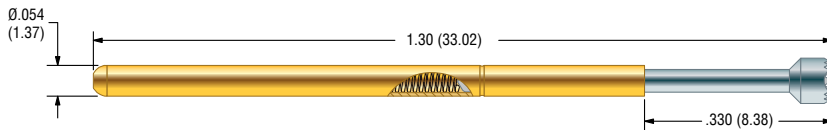

Mechanical

Recommended Travel:	.167 (4.24)
Full Travel:	.250 (6.35)
Operating Temperature:	-55°C to +105°C

Spring Force in oz. (grams)

	Order Code	Preload	Rec. Travel
Standard	-4	0.84 (23.8)	4.0 (113)
Alternate	-6	3.08 (87.3)	6.0 (170)

Electrical (Static Conditions)

Current Rating:	8 amps
Average Probe Resistance:	8 mOhms



Materials and Finishes

- Plunger: BeCu, LFRE proprietary plating
- Barrel: Nickel Silver, Gold plated
- Spring
 - Standard: Stainless Steel
 - Alternate: Music Wire

Receptacle

- Hole diameter: \varnothing .067 to .069 (1.70 to 1.75)
- Suggested drill: #51 or 1.75 mm
- Material
 - SPR Housing: Work-hardened Nickel Silver, Gold plated over hard Nickel
 - EPR Housing: Nickel Silver, unplated
- Post: Phosphorous Bronze, Gold plated

Tip Style

H	HF				
\varnothing .060 (1.52)	\varnothing .080 (2.03)				
					

Solar Panel Test Probe SPP-25 Benefit Summary

Spring probe technology is an ideal solution to provide electrical connection to obtain I-V curve measurements, or providing reliable contact for your challenging high current or low voltage connections. SPP-25 probes feature low, stable resistance, a center close for enhanced pointing accuracy, tip styles designed to distribute spring force across a large area, and two force options; 4oz and 6oz. The probes are specifically designed to yield a linear force-compression relationship as the probe is actuated. This minimizes potentially harmful jumps or steps in force.

Dimensions in inches (millimeters). Specifications subject to change without notice. Consult factory for other temperature requirements, and applications below -40°C. Stocking Disclaimer: Stocking levels for part numbers listed in this catalog are subject to change. Availability is based on current levels of usage and demand.



Page left blank intentionally

GENERAL PURPOSE – EPOXY OR SOLDER MOUNT

The ECT / Pylon line of standard products includes non-replaceable Pogo contacts. They differ from replaceable contacts in that they do not require a socket or receptacle and are designed to be permanently mounted. Non-replaceable probes are designed for industrial applications where typical probe life meets or exceeds those of the end-use product. They are often located inside the end product where probe replacement is either impossible or end-product damage would occur.

Electrical connections are usually made with a soldered connection for electrical and mechanical stability.

The probe is retained in the retention plate with either epoxy or solder on the outside of the probe body.

Non-replaceable Pogo contacts are another example of ECT and Pylon's quality and innovation and how it can work for you.

Epoxy Mount

EPOXY MOUNT INSTRUCTIONS

ECT non-replaceable products may be retained in mounting holes using solder or adhesives.

- Solder mount If conductivity is required, we recommend utilizing solder mounting for retention.
- Epoxy mount If conductivity is not required, utilizing epoxy adhesives for mounting is acceptable.

Adhesives used are typically two-part epoxies, and can be either conductive or non-conductive dependent upon the application. ECT does not recommend the use of fast setting Superglue® style adhesives as they can outgas and may put a nearly invisible barrier on contact surfaces. Epoxy mounting, when properly utilized, provides excellent holding or retention ability compared to traditional mounting techniques such as solder mounting.

Several types of epoxies are available for use, depending on whether conductivity is required, the desired set time, the temperature of application and the requirements and temperature in the end use.

The following epoxy adhesives are known to work well in typical customer applications:

- DEVCON #14277 Two-part epoxy
- Loctite 3140 Hysol Epoxy Resin
- Loctite 3164 Hysol Epoxy Hardener
- DURALCO #4525 Room temperature curing epoxy

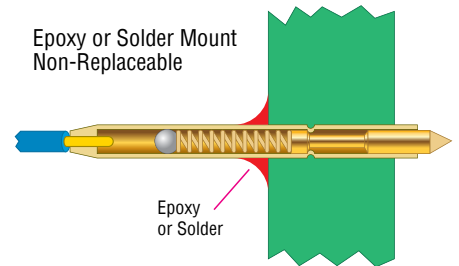

EPOXY MOUNTING PROCEDURE

1. The probe barrel must be clean and free of any coatings, paint, or other materials.
2. Additionally, the plated through hole, or mounting hole must be clean and free of any coatings, paint, or other materials.
3. To install the probe, apply a thin layer of conductive epoxy to the clean inside area of the mounting hole or to the clean outside of the probe barrel, according to manufacturer's directions.
4. If desired, apply a release agent, on all other surfaces to keep the epoxy from adhering to undesirable locations. Utilize a release agent which is compatible with your process.
5. If the depth of the mounting hole is shallow, ensure that a fixture is used to ensure perpendicularity of the probe to the mounting plane.
6. Once the epoxy hardens, or sets up to an acceptable stiff plastic consistency, remove any fixturing or release agents.



MEP-22B

20 mil (0.51 mm)

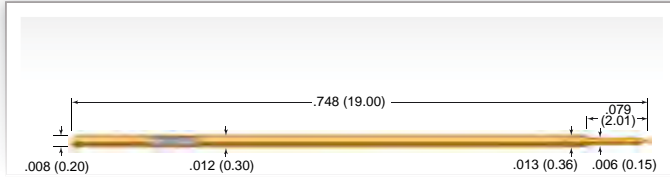

MEPJ-22BD

20 mil (0.51 mm)

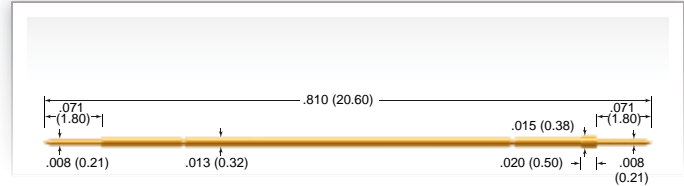

Mechanical

Recommended Travel: .050 (1.27)
 Full Travel: .079 (2.01)
 Operating Temperature: -55°C to +105°C

Spring Force in oz. (grams)

	Preload	Rec. Travel
Standard	0.51 (14)	1.69 (48)

Electrical (Static Conditions)

Current Rating: 2 amps
 Average Probe Resistance: <125 mOhms

Materials and Finishes

Plunger: Heat-treated Steel, Nickel Boron plated
 Barrel: BeCu alloy, Gold plated
 Spring: Music Wire, Gold plated

Mounting

Hole diameter: Ø .0135 to .0140 (0.34 to 0.36)
 Suggested drill: #80 or 0.35 mm

Tip Style

B				
Ø .006 (0.15)				
				

Mechanical

Recommended Travel: .052 (1.33)
 Full Travel: .079 (2.01)
 Operating Temperature: -55°C to +105°C

Spring Force in oz. (grams)

	Preload	Rec. Travel
Standard	0.38 (11)	1.69 (48)

Electrical (Static Conditions)

Current Rating: 2 amps
 Average Probe Resistance: <125 mOhms

Materials and Finishes

Plunger: Heat-treated Steel, Nickel Boron plated
 Barrel: Phosphor Bronze, Gold plated
 Spring: Music Wire, Gold plated

Mounting

Hole diameter: Ø .0135 to .0140 (0.34 to 0.36)
 Suggested drill: #80 or 0.35 mm

Tip Style

B				
Ø .008 (0.20)				
				

HIB & DUT

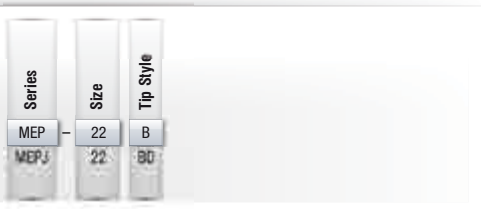

A-A-S
39 mil (1.00 mm)

A-S
50 mil (1.27 mm)

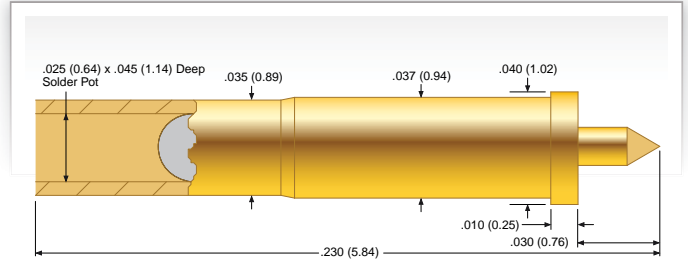
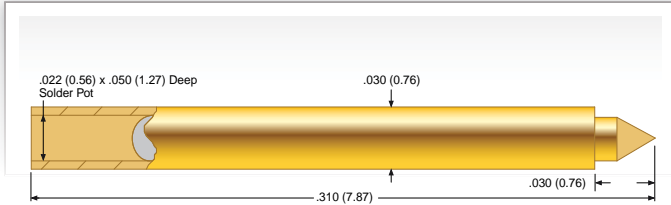

Mechanical

Recommended Travel: .020 (0.51)
 Full Travel: .030 (0.76)
 Operating Temperature: -55°C to +150°C

Spring Force in oz. (grams)

	Preload	Rec. Travel
Standard	0.5 (14)	2.0 (57)

Electrical (Static Conditions)

Current Rating: 2 amps
 Average Probe Resistance: <30 mOhms

Materials and Finishes

Plunger: Heat treated BeCu, Gold plated
 Barrel: Phosphor Bronze, Gold plated
 Spring: Stainless Steel, Gold plated
 Ball: Stainless Steel, Gold plated

Epoxy Mounting

Hole diameter: Ø .0315 (0.80)
 Suggested drill: #68 or 0.79 mm

Tip Style

C	R			
Ø .021 (0.53)	Ø .021 (0.53)			

Mechanical

Recommended Travel: .020 (0.51)
 Full Travel: .030 (0.76)
 Operating Temperature: -55°C to +150°C

Spring Force in oz. (grams)

	Preload	Rec. Travel
Standard	0.7 (20)	1.3 (37)

Electrical (Static Conditions)

Current Rating: 2 amps
 Average Probe Resistance: <30 mOhms

Materials and Finishes

Plunger: Heat treated BeCu or Brass, Gold plated
 Barrel: Brass, Gold plated
 Spring: Stainless Steel, Gold plated
 Ball: Stainless Steel, Gold plated

Mounting

Hole diameter: Ø .0380 (0.97)
 Suggested drill: #62 or 0.97 mm

Tip Style

C	R	V		
Ø .014 (0.36)	Ø .014 (0.36)	Ø .014 (0.36)		
	Brass			

Dimensions in inches (millimeters). Specifications subject to change without notice. Consult factory for other temperature requirements, and applications below -40°C. Stocking Disclaimer: Stocking levels for part numbers listed in this catalog are subject to change. Availability is based on current levels of usage and demand.

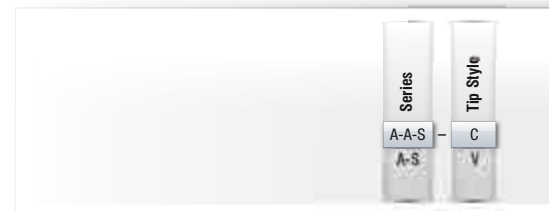

C-S

75 mil (1.91 mm)

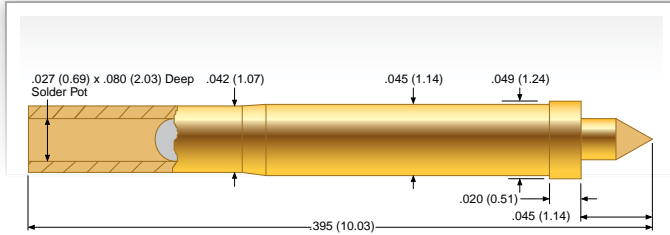

E-S

100 mil (2.54 mm)

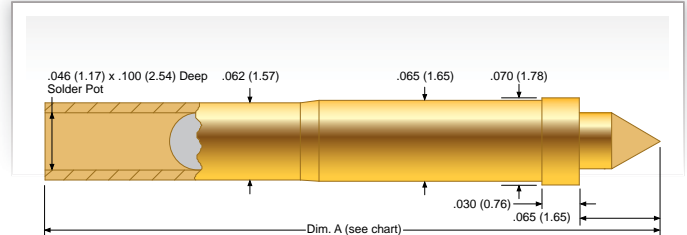

Mechanical

Recommended Travel: .030 (0.76)
 Full Travel: .045 (1.14)
 Operating Temperature: -55°C to +150°C

Spring Force in oz. (grams)

	Preload	Rec. Travel
Standard	0.5 (14)	3.4 (96)

Electrical (Static Conditions)

Current Rating: 5 amps
 Average Probe Resistance: <30 mOhms

Materials and Finishes

Plunger: Heat treated BeCu, Gold plated
 Barrel: Brass, Gold plated
 Spring: Stainless Steel, Gold plated
 Ball: Stainless Steel, Gold plated

Epoxy Mounting

Hole diameter: Ø .0465 (1.18)
 Suggested drill: #56

Tip Style

C	R			
Ø .026 (0.66)	Ø .026 (0.66)			

Mechanical

Recommended Travel: .043 (1.09)
 Full Travel: .065 (1.65)
 Operating Temperature: -55°C to +150°C

Spring Force in oz. (grams)

	Preload	Rec. Travel
Standard	1.0 (29)	2.75 (78)

Electrical (Static Conditions)

Current Rating: 5 amps
 Average Probe Resistance: <30 mOhms

Materials and Finishes

Plunger: Heat treated BeCu, Gold plated
 Barrel: Brass, Gold plated
 Spring: Stainless Steel, Gold plated
 Ball: Stainless Steel, Gold plated

Epoxy Mounting

Hole diameter: Ø .0670 (1.70)
 Suggested drill: #51

Probe Overall Length

Model No.	Overall Length (Dim A)
E-S-C, F,R	.495 (12.57)
E-S-V, W	.540 (13.72)

Tip Style

C	F	R	V	W
Ø .045 (1.14)	Ø .045 (1.14)	Ø .045 (1.14)	Ø .090 (2.29)	Ø .070 (1.78)

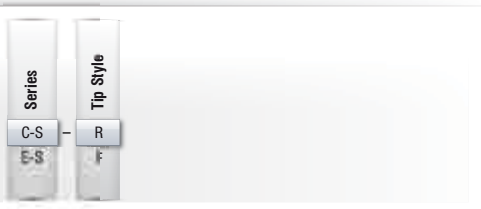

F-S

125 mil (3.18 mm)

G-S

125 mil (3.18 mm)

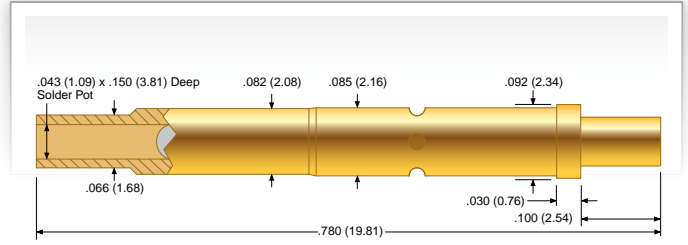
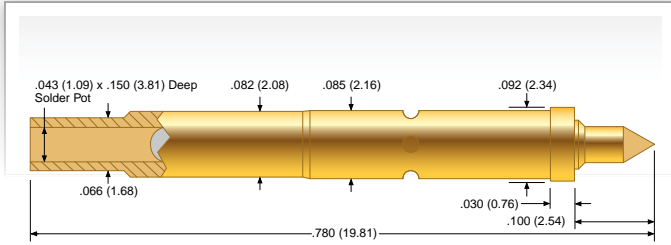

Mechanical

Recommended Travel: .066 (1.68)
 Full Travel: .100 (2.54)
 Operating Temperature: -55°C to +150°C

Spring Force in oz. (grams)

	Preload	Rec. Travel
Standard	2.0 (57)	6.0 (170)

Electrical (Static Conditions)

Current Rating: 5 amps
 Average Probe Resistance: <30 mOhms

Materials and Finishes

Plunger: Heat treated BeCu, Gold plated or Heat treated Brass, Gold plated
 Barrel: Brass, Gold plated
 Spring: Stainless Steel, Gold plated
 Ball: Stainless Steel, Gold plated

Epoxy Mounting

Hole diameter: Ø .0860 (2.18)
 Suggested drill: #44

Tip Style

C	R	W		
Ø .045 (1.14)	Ø .045 (1.14)	Ø .090 (2.29)		
	Brass			

Mechanical

Recommended Travel: .067 (1.68)
 Full Travel: .100 (2.54)
 Operating Temperature: -55°C to +150°C

Spring Force in oz. (grams)

	Preload	Rec. Travel
Standard	3.0 (85)	6.0 (170)

Electrical (Static Conditions)

Current Rating: 5 amps
 Average Probe Resistance: <30 mOhms

Materials and Finishes

Plunger: Heat treated BeCu, Gold plated
 Barrel: Brass, Gold plated
 Spring: Stainless Steel, Gold plated
 Ball: Stainless Steel, Gold plated

Mounting

Hole diameter: Ø .0860 (2.18)
 Suggested drill: #44

Tip Style

F	R			
Ø .061 (1.55)	Ø .061 (1.55)			

Dimensions in inches (millimeters). Specifications subject to change without notice. Consult factory for other temperature requirements, and applications below -40°C. Stocking Disclaimer: Stocking levels for part numbers listed in this catalog are subject to change. Availability is based on current levels of usage and demand.

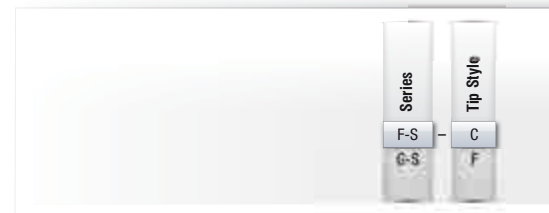

P2532

156 mil (3.96 mm)

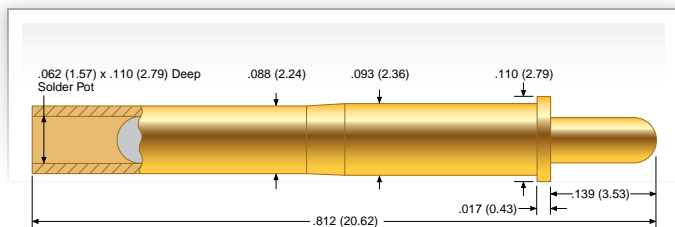

Mechanical

Recommended Travel: .093 (2.36)
 Full Travel: .139 (3.53)
 Operating Temperature: -55°C to +150°C

Spring Force in oz. (grams)

	Preload	Rec. Travel
Standard	1.0 (28)	2.3 (65)

Electrical (Static Conditions)

Current Rating: 5 amps
 Average Probe Resistance: <30 mOhms

Materials and Finishes

Plunger: Heat-treated BeCu, Gold plated over hard Nickel
 Barrel: Brass, Gold plated
 Spring: Stainless Steel, Gold plated
 Ball: Stainless Steel, Gold plated

Epoxy Mounting

Hole diameter: Ø .0945 (2.40)
 Suggested drill: #41 mm or 2.40 mm

Tip Style

1	2			
Ø .059 (1.50)	Ø .059 (1.50)			

P2550

187 mil (4.75 mm)

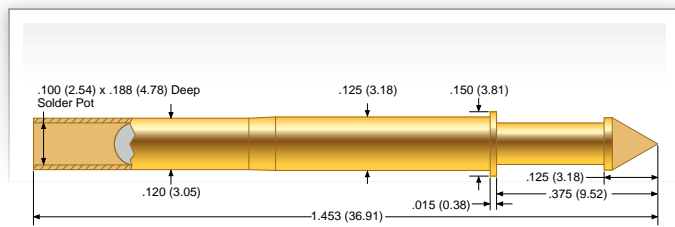

Mechanical

Recommended Travel: .167 (4.24)
 Full Travel: .250 (6.35)
 Operating Temperature: -55°C to +150°C

Spring Force in oz. (grams)

	Order Code	Preload	Rec. Travel
Standard		1.00 (28)	3.20 (91)
High	-8	4.00 (113)	6.70 (190)

Electrical (Static Conditions)

Current Rating: 5 amps
 Average Probe Resistance: <30 mOhms

Materials and Finishes

Plunger: Heat-treated BeCu, Gold plated over hard Nickel
 Barrel: Brass, Gold plated
 Spring: Stainless Steel, Gold plated
 Ball: Stainless Steel, Gold plated

Epoxy Mounting

Hole diameter: Ø .126 (3.20)
 Suggested drill: #30 or 3.20 mm

Tip Style

8	0	6	9	
Ø .156 (3.96)	Ø .122 (3.10)	Ø .154 (3.91)	Ø .125 (3.18)	



GENERAL PURPOSE – PRESS RING MOUNT

The ECT / Pylon line of standard products includes non-replaceable Pogo contacts. They differ from replaceable contacts in that they do not require a socket or receptacle and are designed to be permanently mounted. Non-replaceable probes are designed for industrial applications where typical probe life meets or exceeds those of the end-use product. They are usually located inside the end product where probe replacement is either impossible or end-product damage would occur.

Electrical connections are typically made by crimping or soldering a wire at the terminal of the probe.

The probe is retained in the retention plate by its press ring, which deforms during the installation process and therefore provides a permanent mount.

Press Ring Mount

Press Ring Mount
Non-Replaceable

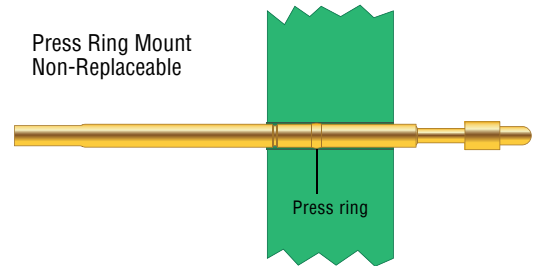

MEP-20

25 mil (0.635 mm)

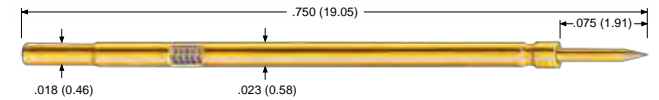

Mechanical

Recommended Travel: .050 (1.27)
 Full Travel: .075 (1.91)
 Operating Temperature: -55°C to +105°C

Spring Force in oz. (grams)

	Preload	Rec. Travel
Standard	.39 (11)	1.39 (39)

Electrical (Static Conditions)

Current Rating: 2 amps
 Average Probe Resistance: <50 mOhms

Materials and Finishes

Plunger: Heat-treated BeCu, Gold plated over hard Nickel
 Barrel: Work hardened BeCu, Gold plated over hard Nickel
 Spring: Music Wire, Silver plated

Mounting

Hole diameter: Ø .0205 to .0215 (0.52 to 0.55)
 Suggested drill: #75 or 0.52 mm
 Minimum mounting plate thickness: .250 (6.35)

Order versions

MEP-20x Crimp
 MEP-20x-30 Crimp with 30 inches of 30 AWG wire attached

Application

1. The MEP-20 can also be mounted in a staggered pattern to access test pads on centers less than .025".
2. Recommended wire gauge 30 AWG, maximum insulation dia. .019 (0.48).
3. Shrink tubing is recommended for use on alternating receptacles to reduce the possibility of electrical shorting.

Tip Style

B	G	J	U	
Ø .010 (0.25)	Ø .010 (0.25)	Ø .010 (0.25)	Ø .006 (0.15)	

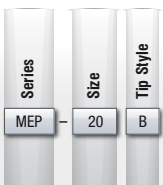

HIGH CURRENT PROBE

The maximum continuous current rating of a spring probe is determined by its design, size and construction. Typical probes are rated from 2 to 8 amps maximum continuous current at working travel. While this is sufficient for most board test applications, higher current applications will require a much more solid and rugged probe to withstand current capabilities of 10 to 150 amps and beyond.

Our high current probes features

- Low resistance plungers
- PogoPlus® bias ball construction
- High current optimized base material and plating
- Higher temperature spring design
- Specialized high current tip geometry

Another high current solution is our Feed-Through Plunger probe line. As the name describes, the plunger moves right through the probe and is made from a single piece, keeping internal resistance of the probe at a minimum.

With increasing current, any resistance within the probe will generate heat. The higher the current the more heat is generated.

Another consideration is test cycle time. All probes are rated at continuously current carrying capability. During a test sequence the current might not be present at all time, giving the probe time to cool off and potentially being able to carry far more than the rated amps on the datasheet. Please contact ECT for details on higher or pulsed current applications.

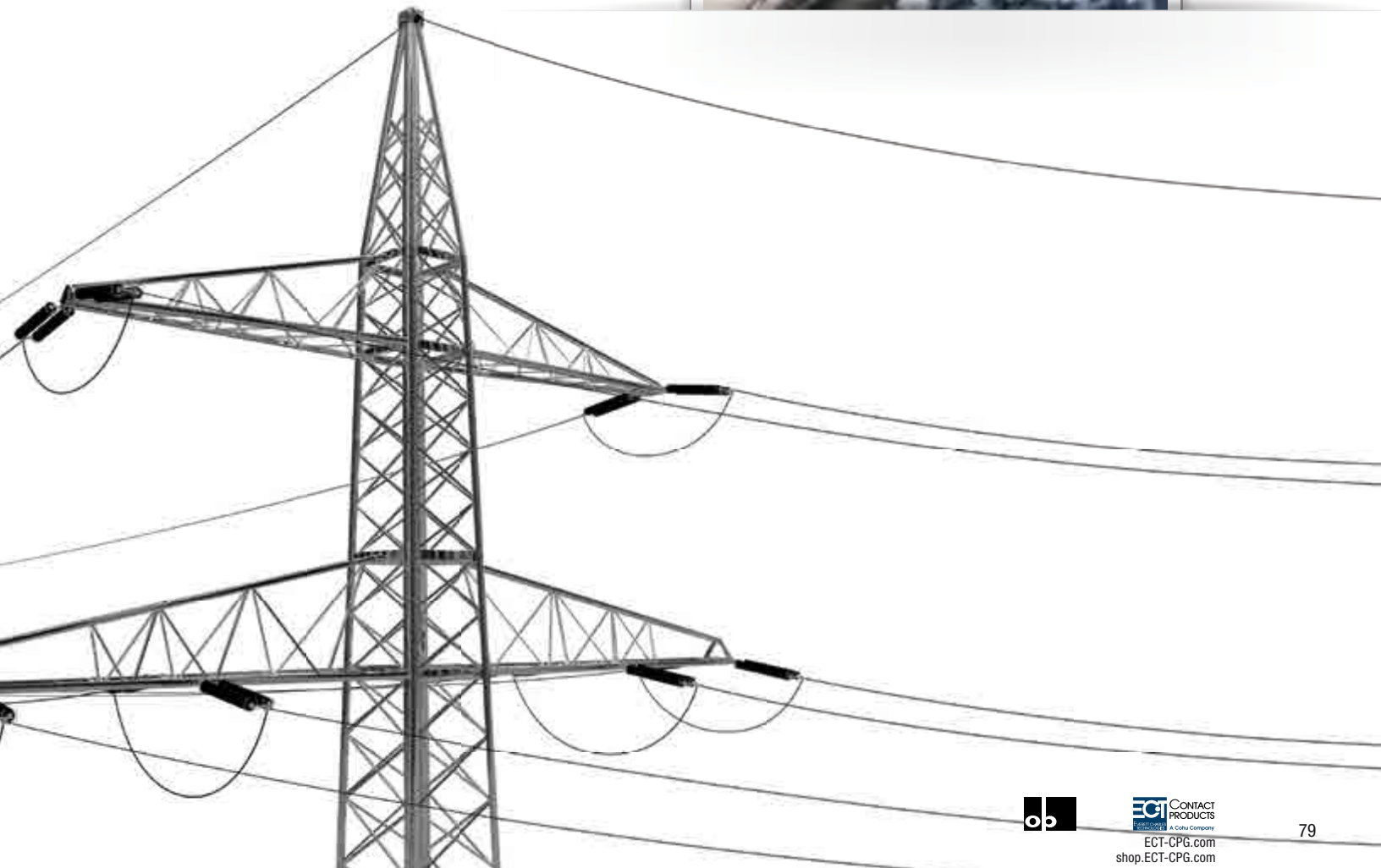

High Current Probe

HCP-25

100 mil (2.54 mm)

HCP-13

125 mil (3.18 mm)

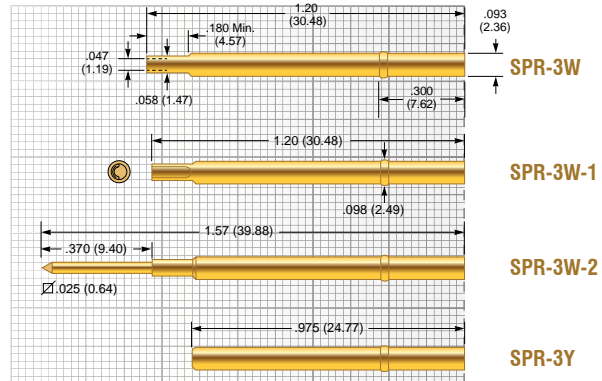
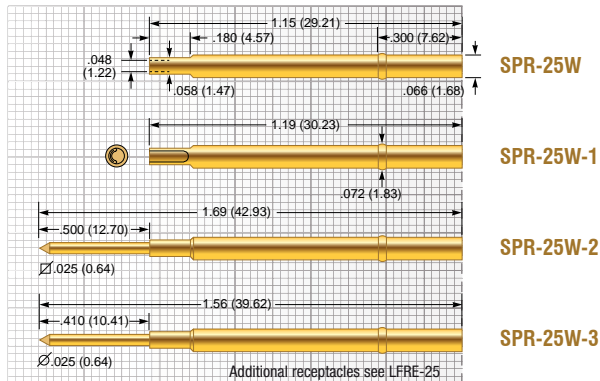
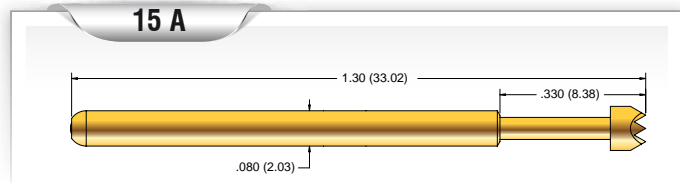
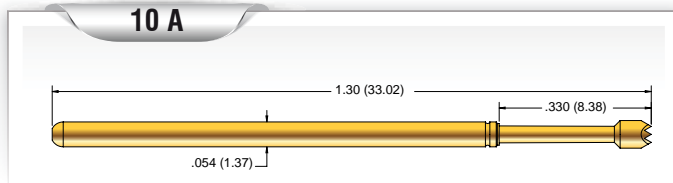

Mechanical

Recommended Travel:	.167 (4.24)
Full Travel:	.250 (6.35)
Operating Temperature:	-55°C to +150°C

Spring Force in oz. (grams)

	Order Code	Preload	Rec. Travel
Standard		1.29 (37)	4.0 (113)
Alternate	-1	2.23 (63)	8.00 (227)

Electrical (Static Conditions)

Current Rating:	10 amps
Average Probe Resistance:	<25 mOhms

Materials and Finishes

Plunger:	Heat-treated BeCu, Gold plated over hard Nickel
Barrel:	Phosphor Bronze, Gold plated over Silver
Spring:	Stainless Steel, Silver plated
Bias Ball:	Stainless Steel

Receptacle

Hole diameter:	Ø .067 to .069 (1.70 to 1.75)
Suggested drill:	#51 or 1.70 mm
Material Housing:	Work-hardened Nickel Silver, Gold plated over hard Nickel
Material Post:	Phosphorous Bronze, Gold plated

Mechanical

Recommended Travel:	.167 (4.24)
Full Travel:	.250 (6.35)
Operating Temperature:	-55°C to +150°C

Spring Force in oz. (grams)

	Order Code	Preload	Rec. Travel
Standard		1.44 (41)	4.5 (128)
Alternate	-1	2.43 (69)	8.00 (227)

Electrical (Static Conditions)

Current Rating:	15 amps
Average Probe Resistance:	<25 mOhms

Materials and Finishes

Plunger:	Heat-treated BeCu, Gold plated over hard Nickel
Barrel:	Phosphor Bronze, Gold plated over Silver
Spring:	Stainless Steel, Silver plated
Bias Ball:	Stainless Steel
Terminal Ball:	Stainless Steel

Receptacle

Hole diameter:	Ø .094 to .096 (2.39 to 2.44)
Suggested drill:	#41 or 2.40 mm
Material Housing:	Work-hardened Nickel Silver, Gold plated over hard Nickel
Material Post:	Phosphorous Bronze, Gold plated

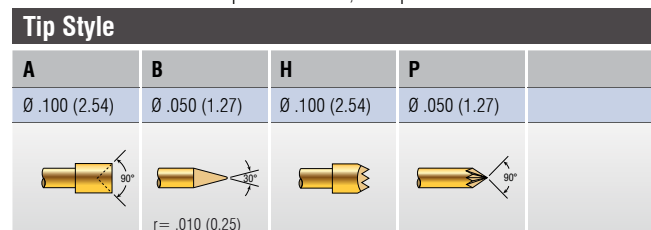
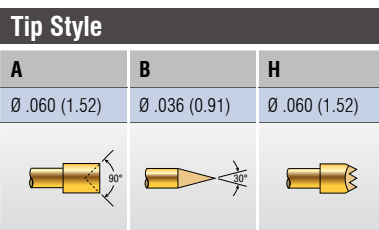

HCP-14

187 mil (4.75 mm)

HCP-15

187 mil (4.75 mm)

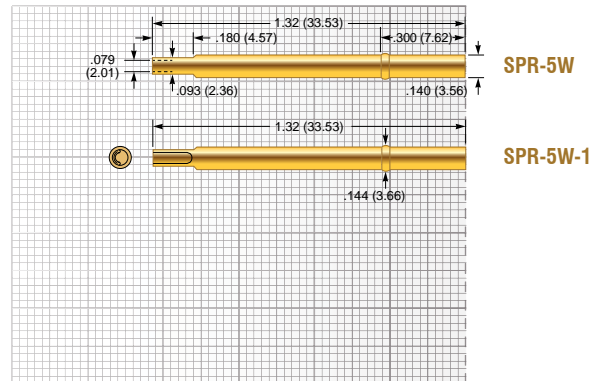
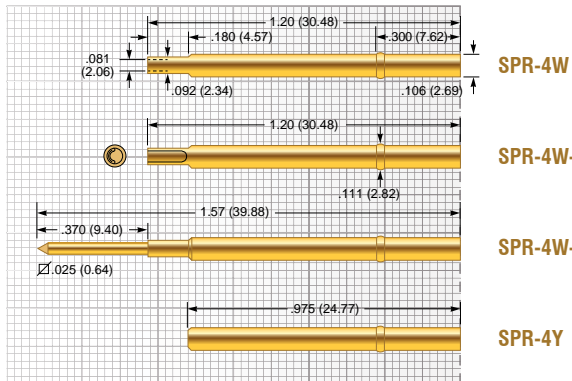
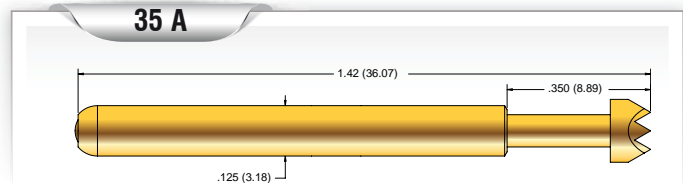
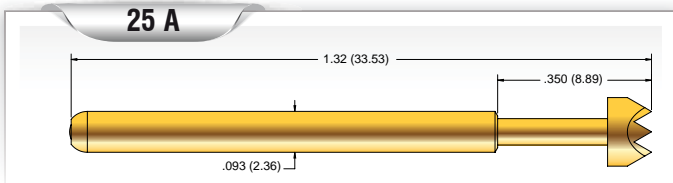

Mechanical

Recommended Travel:	.167 (4.24)
Full Travel:	.250 (6.35)
Operating Temperature:	-55°C to +150°C

Spring Force in oz. (grams)

Order Code	Preload	Rec. Travel
Standard	0.86 (24)	4.8 (136)
Alternate -1	4.32 (122)	12.0 (340)

Electrical (Static Conditions)

Current Rating:	25 amps
Average Probe Resistance:	<25 mOhms

Materials and Finishes

Plunger:	Heat-treated BeCu, Gold plated over hard Nickel
Barrel:	Phosphor Bronze, Gold plated over Silver
Spring:	Stainless Steel, Silver plated
Bias Ball:	Stainless Steel
Terminal Ball:	Stainless Steel

Receptacle

Hole diameter:	Ø .107 to .109 (2.72 to 2.77)
Suggested drill:	2.75 mm
Material Housing:	Work-hardened Nickel Silver, Gold plated over hard Nickel
Material Post:	Phosphorous Bronze, Gold plated

Tip Style

A	B	H
Ø .156 (3.96)	Ø .060 (1.52)	Ø .156 (3.96)
r = .010 (0.25)		

Mechanical

Recommended Travel:	.167 (4.24)
Full Travel:	.250 (6.35)
Operating Temperature:	-55°C to +150°C

Spring Force in oz. (grams)

Order Code	Preload	Rec. Travel
Standard	3.76 (107)	16.0 (456)
Alternate -1	6.05 (172)	24.0 (680)

Electrical (Static Conditions)

Current Rating:	35 amps
Average Probe Resistance:	<25 mOhms

Materials and Finishes

Plunger:	Heat-treated BeCu, Gold plated over hard Nickel
Barrel:	Phosphor Bronze, Gold plated over Silver
Spring:	Stainless Steel, Silver plated
Bias Ball:	Stainless Steel
Terminal Ball:	Stainless Steel

Receptacle

Hole diameter:	Ø .141 to .143 (3.58 to 3.63)
Suggested drill:	3.60 mm
Material Housing:	Work-hardened Nickel Silver, Gold plated over hard Nickel

Tip Style

A	B	H
Ø .156 (3.96)	Ø .080 (2.03)	Ø .156 (3.96)
r = .010 (0.25)		

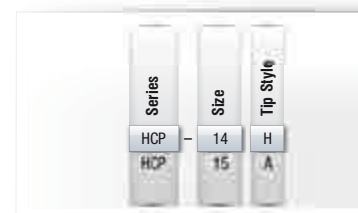

Dimensions in inches (millimeters). Specifications subject to change without notice. Consult factory for other temperature requirements, and applications below -40°C. Stocking Disclaimer: Stocking levels for part numbers listed in this catalog are subject to change. Availability is based on current levels of usage and demand.



P3325

125 mil (3.18 mm)

P2447-1W

225 mil (5.72 mm)

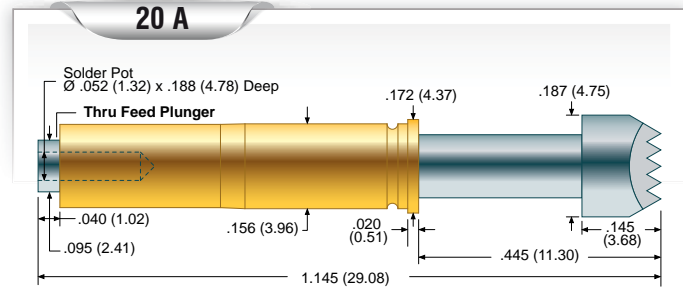
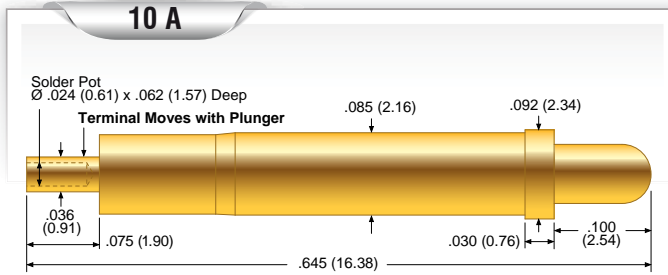

Mechanical

Recommended Travel: .066 (1.68)
 Full Travel: .100 (2.54)
 Operating Temperature: -55°C to +105°C

Spring Force in oz. (grams)

	Preload	Rec. Travel
Standard	5.0 (142)	8.3 (235)

Electrical (Static Conditions)

Current Rating: 10 amps
 Average Probe Resistance: <10 mOhms

Materials and Finishes

Plunger: Hardened BeCu, Gold plated
 Barrel: Brass
 Spring: Music Wire

Mounting Options

Hole diameter: Ø .086 (2.18)
 Suggested drill: #44 or 2.18 mm

Tip Style

0	1		
Ø .061 (1.55)	Ø .090 (2.29)		



Mechanical

Recommended Travel: .200 (5.08)
 Full Travel: .300 (7.62)
 Operating Temperature: -55°C to +150°C

Spring Force in oz. (grams)

	Preload	Rec. Travel
Standard	6.0 (170)	14.0 (397)

Electrical (Static Conditions)

Current Rating: 20 amps
 Average Probe Resistance: <10 mOhms

Materials and Finishes

Plunger: Hardened BeCu, Nickel plated
 Barrel: Brass
 Spring: Stainless Steel

Mounting Options

Hole diameter: Ø .157 (3.99)
 Suggested drill: #22 or 3.99 mm

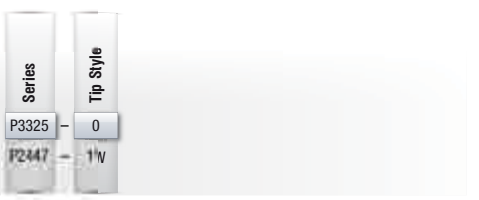

P4301

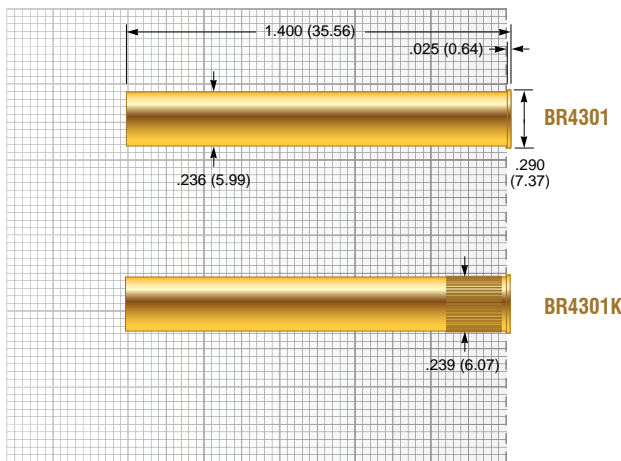
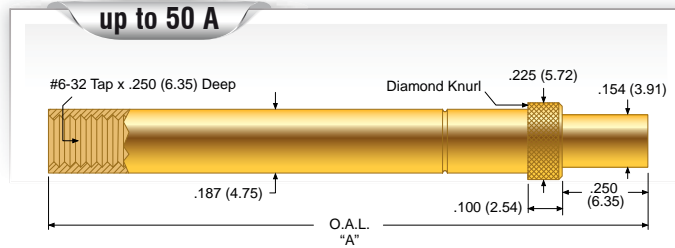

Tip Style					
1F	1R	1W	1Z	2F	2R
Ø .154 (3.91)	Ø .154 (3.91)	Ø .154 (3.91)	Ø .200 (5.08)	Ø .154 (3.91)	Ø .154 (3.91)

up to 50 A

Mechanical

Recommended Travel: .167 (4.24)
 Full Travel: .250 (6.35)
 Operating Temperature: -55°C to +150°C

Spring Force in oz. (grams)

	Preload	Rec. Travel
Standard	16 (454)	25.7 (729)

Electrical (Static Conditions)

Current Rating BeCu: 40 amps
 Current Rating Tellurium Copper: 50 amps
 Average Probe Resistance: <5 mOhms

Materials and Finishes

Plunger (1F) Tellurium Copper, Gold plated
 Plunger: BeCu, Gold plated
 Barrel: Tellurium Copper, Gold plated
 Spring: Stainless Steel
 Ball: Stainless Steel

Probe Overall Length

Model No.	Overall Length (Dim. A)
P4301-1F, -1R, -1W	1.75 (44.45)
P4301-1Z	1.86 (47.24)
P4301-2F, -2R	2.00 (50.80)

Receptacle

Hole diameter: Ø .238 (6.05)
 Suggested drill: #B or 6.05 mm
 Material Housing: Phosphor Bronze, Gold plated

Dimensions in inches (millimeters). Specifications subject to change without notice. Consult factory for other temperature requirements, and applications below -40°C. Stocking Disclaimer: Stocking levels for part numbers listed in this catalog are subject to change. Availability is based on current levels of usage and demand.

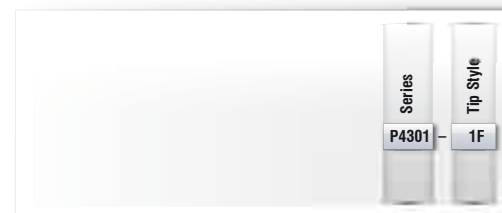

HC375

HC500

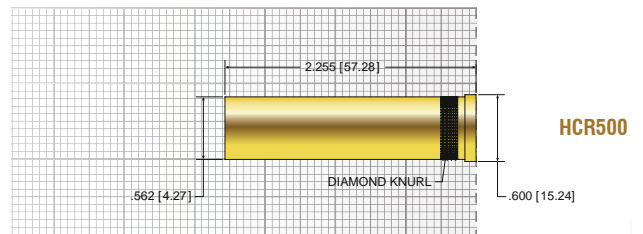
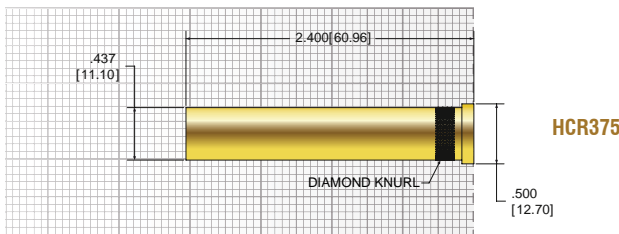
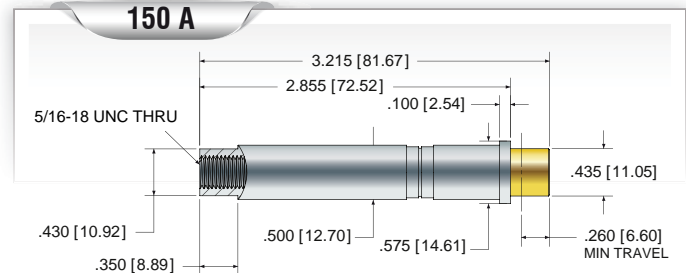
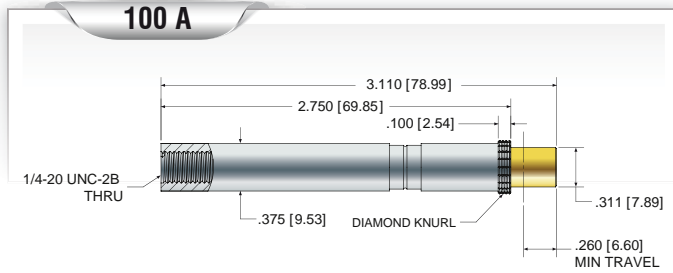

Mechanical

Recommended Travel: .250 (6.35)
 Full Travel: .360 (9.14)
 Operating Temperature: -55°C to +155°C

Spring Force in oz. (grams)

	Order Code	Preload	Rec. Travel
Standard	-4	27.2 (771)	64 (1814)
Alternate	-6	24.0 (680)	96 (2722)

Electrical (Static Conditions)

Current Rating: 100 amps
 Average Probe Resistance: <25 mOhms

Materials and Finishes

Plunger: BeCu Gold plated
 Barrel: Brass Silver plated
 Spring: Stainless Steel

Mechanical

Recommended Travel: .250 (6.35)
 Full Travel: .260 (6.60)
 Operating Temperature: -55°C to +155°C

Spring Force in oz. (grams)

	Preload	Rec. Travel
Standard	22.08 (626)	220.8 (6260)

Electrical (Static Conditions)

Current Rating: 150 amps
 Average Probe Resistance: <25 mOhms

Materials and Finishes

Plunger: BeCu Gold plated
 Barrel: Brass Silver plated
 Spring: Stainless Steel Silver plated

Receptacle

Hole Diameter: Ø .571 - Ø .5679 (14.50 mm)
 Suggested drill: 14.50 mm
 Material Housing: Work-hardend Brass, Gold plated over hard Nickel

Tip Style (additional styles on request)

F			
Ø .311 (7.89)			

Tip Style (additional styles on request)

F			
Ø .435 (11.05)			

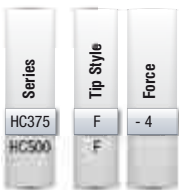

HIGH FREQUENCY

High Frequency or Radio Frequency (RF) coaxial probes are used for testing high speed circuits in a variety of industries including automotive, wireless communications, satellite, and more.

The precisely controlled physical and electrical characteristics of ECT's RF coaxial probes make them an ideal 50 ohm impedance port-extending accessory for network analyzers and time domain reflectometers. The RF center conductor is captivated for maximum reliability. RF coaxial probes incorporate spring probes in an open architecture format to accommodate a wide range of physical circuit topologies and to alleviate the need for special geometry contact pads on the circuit under test.

The instrumentation side is configured for reliable and easy connection to SMA, SMB or MMCX. If you don't find a configuration that aligns to your requirements, our team of engineers will provide a solution tailored to your specifications.



CSP-30ES-013

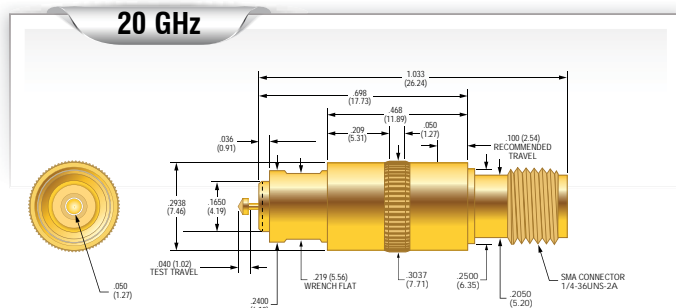

Connection to SMA Connector

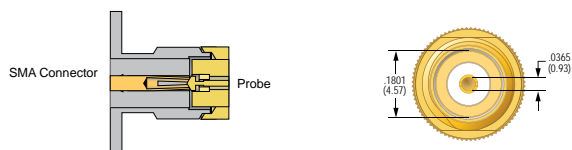

Mechanical

Recommended Travel:	.100 (2.54)
Recommended Travel inner conductor:	.040 (1.02)
Recommended Travel outer conductor:	.100 (2.54)
Full Travel:	.200 (5.08)
Operating Temperature:	-55°C to 85°C
Connection (instrument side):	SMA Connector, 1/4 -36UNS-2A

Spring Force in oz. (grams)

	Order Code	Preload	Rec. Travel
Standard	CSP-30ES-013	3.06 (86)	4.0 (113)

Electrical (Static Conditions)

Nominal Impedance:	50 Ohms
Average Probe Resistance:	<50 mOhms
Bandwidth @ -1 dB:	>20 GHz

Materials and Finishes

Housing:	Brass, Gold plated
Dielectric:	Rexolite
Spring:	Stainless Steel, Gold plated over hard Nickel

Mounting

Hole diameter:	Ø.297 (7.54)
----------------	--------------

Replaceable Probes

Order Number (CSP-30ES-013):	SPL-30E-030
------------------------------	-------------

Applications

The CSP-30ES-013 was specifically designed to mate with SMA connectors. Designed for use in interconnect applications where signal integrity is required, such as accessing high frequency RF connectors on circuit boards. Can also be used as R.F. mating connector.

CSP-30TS-011

CSP-03B-006 CSP-03G-003

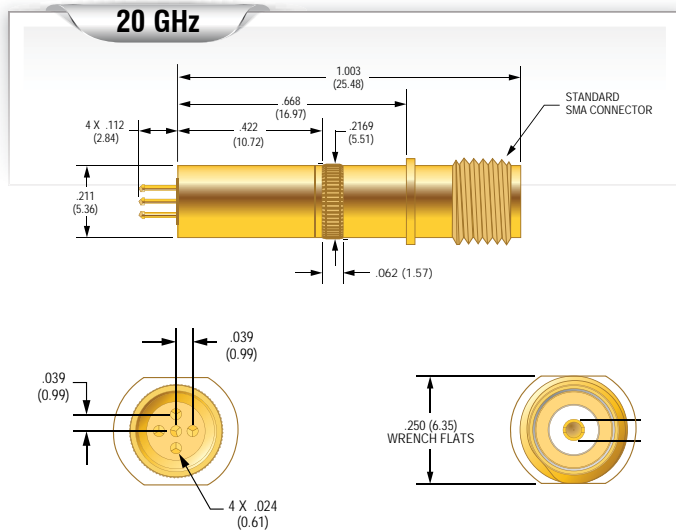

Mechanical

Recommended Travel:	.067 (1.70)
Full Travel:	.100 (2.54)
Operating Temperature:	-55°C to 85°C
Connection:	Standard SMA Connector

Spring Force in oz. (grams)

Order Code	Preload	Rec. Travel
Standard CSP-30TS-011	1.59 (40)*	7.0 (198)*

* Fully populated - 5 probes total

Electrical (Static Conditions)

Nominal Impedance:	50 Ohms
Average Probe Resistance:	<50 mOhms
Bandwidth @ -1 dB:	>20 GHz

Materials and Finishes

Housing:	Brass, Gold plated
Dielectric:	Rexolite
Spring:	Stainless Steel, Gold plated over hard Nickel

Mounting

Hole diameter:	Ø.213 (5.4)
----------------	-------------

Replaceable Probes

Order Number (CSP-30TS-011):	
Signal	SPL-30T-020
Ground	SPL-30T-021

Applications

Designed for interconnect applications where signal integrity is required, such as accessing high frequency RF targets on circuit boards. Can also be used as R.F. mating connector.

Mounting tool: CIT-30-0

Ships with each CSP-30TS-011



Dimensions in inches (millimeters). Specifications subject to change without notice. Consult factory for other temperature requirements, and applications below -40°C. Stocking Disclaimer: Stocking levels for part numbers listed in this catalog are subject to change. Availability is based on current levels of usage and demand.

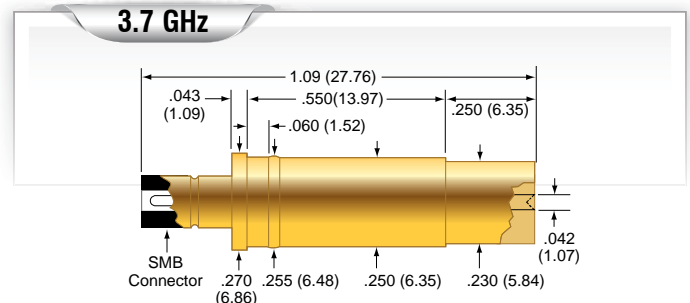

CSP-03B-006

CSP-03G-003

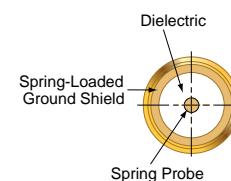

Mechanical

Recommended Travel:	.167 (4.24)
Full Travel:	.250 (6.35)
Operating Temperature:	-35°C to +105°C
Connection:	Standard SMB 27-1 or equivalent Connector

Spring Force in oz. (grams)

Standard	CSP-03B-006	0.80 (22)	4.0 (113)
Standard	CSP-03G-003	0.80 (22)	4.0 (113)

Electrical (Static Conditions)

Nominal Impedance:	50 Ohms
Average Probe Resistance:	<50 mOhms
Dielectric Voltage Rating:	1K VAC
Minimum Insertion Loss @ 1GHz (tested with target):	0.13 dB typical
Maximum VSWR @ 1GHz (tested with target):	1.15:1 typical

Materials and Finishes

Housing:	Brass, Gold plated
Dielectric:	Premium virgin Teflon per MIL-P-18468

Replaceable Probes

Order Number (CSP-03B-006):	SPL-03B-121
Order Number (CSP-03G-003):	SPL-03G-043

Applications

Designed for use in interconnect applications where signal integrity is required, such as accessing high frequency targets on circuit boards. Can also be used as R.F. mating connector.

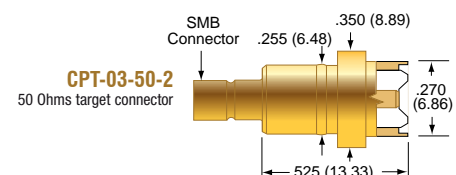

ECT CONTACT PRODUCTS
A Cobu Company
ECT-CPG.com
shop.ECT-CPG.com

High Frequency Probe

CSP-40B-012 CSP-40L-013

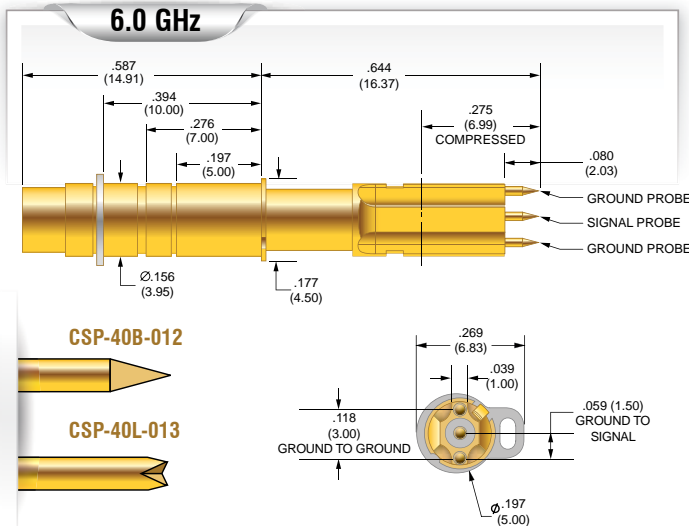

Mechanical

Recommended Travel: 0.133 (3.38) SHIELD, 0.211 (5.36) INCLUDING TRAVEL OF PROBES
 Full Travel: 0.200 (5.08) SHIELD, 0.275 (6.99) INCLUDING TRAVEL OF PROBES
 Operating Temperature: -35°C to +155°C
 Connection: MMCX

Spring Force in oz. (grams)

	Order Code	Preload	Rec. Travel
Standard	CSP-40B-012	1.9 (53.9)	8.0 (226.8)
Standard	CSP-40L-013	1.9 (53.9)	8.0 (226.8)

Electrical (Static Conditions)

Nominal Impedance: 50 Ohms
 Dielectric Voltage Rating: 1K VAC
 Bandwidth @ -1 dB: 6 GHz

Materials and Finishes

Housing: Brass, Gold plated
 Dielectric: Teflon
 Spring: Stainless Steel, Nickel Plated

Replaceable Probes

Ground Probe, Order Number (CSP-40B-012) SPL-00B-089
 Signal Probe, Order Number (CSP-40B-012) SPL-40B-045
 Ground Probe, Order Number (CSP-40L-013) SPL-00L-088
 Signal Probe, Order Number (CSP-40L-013) SPL-40L-046

Applications

The CSP-40 coaxial probe provides instrumentation-quality interface for broadband R.F. measurements up to 6 GHz. With the CSP-40 R.F. Circuit Design, impedance characterization measurements can be performed using it as a Network Analyzer port-extending accessory. Accurate and repeatable small signal and R.F. power (50 Watts) measurements provide consistent and repeatable results.

CSP-40A-015

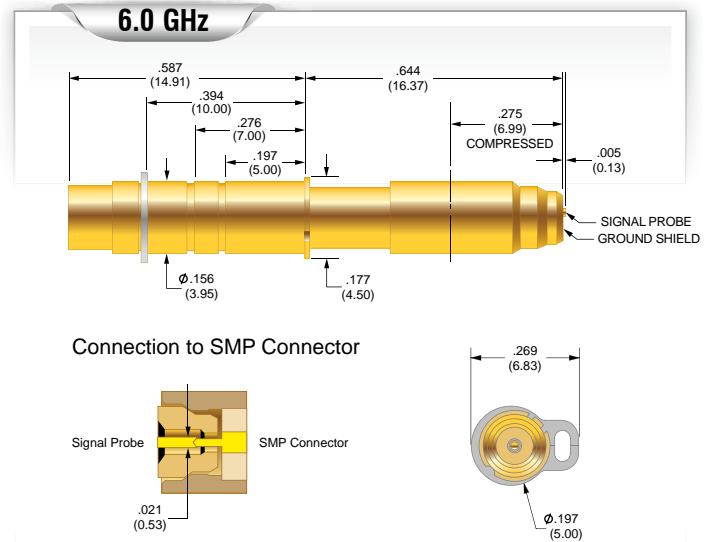

Mechanical

Recommended Travel: 0.133 (3.38) SHIELD, 0.211 (5.36) INCLUDING TRAVEL OF PROBE
 Full Travel: 0.200 (5.08) SHIELD, 0.275 (6.99) INCLUDING TRAVEL OF PROBE
 Operating Temperature: -35°C to +155°C
 Connection: DUT side
 Connection: SMP

Spring Force in oz. (grams)

	Order Code	Preload	Rec. Travel
Standard	CSP-40A-015	6.2 (175.2)	8.0 (226.8)

Electrical (Static Conditions)

Nominal Impedance: 50 Ohms
 Dielectric Voltage Rating: 1K VAC
 Bandwidth @ -1 dB: 6 GHz

Materials and Finishes

Housing: Brass, Gold plated
 Dielectric: Teflon

Replaceable Probes

Signal Probe, Order Number (CSP-40A-015) HPA-40G
 (more information on this probe in the General Purpose section)

Applications

The CSP-40 coaxial probe provides instrumentation-quality interface for broadband R.F. measurements up to 6 GHz to an SMP male connector. With the CSP-40 R.F. Circuit Design, impedance characterization measurements can be performed using it as a Network Analyzer port-extending accessory. Accurate and repeatable small signal and R.F. power (50 Watts) measurements provide consistent and repeatable results.

Dimensions in inches (millimeters). Specifications subject to change without notice.
 Consult factory for other temperature requirements, and applications below -40°C.
 Stocking Disclaimer: Stocking levels for part numbers listed in this catalog are subject to change.
 Availability is based on current levels of usage and demand.

CSP-40A-024 CSP-40G-021

K-50B-S K-50H-S

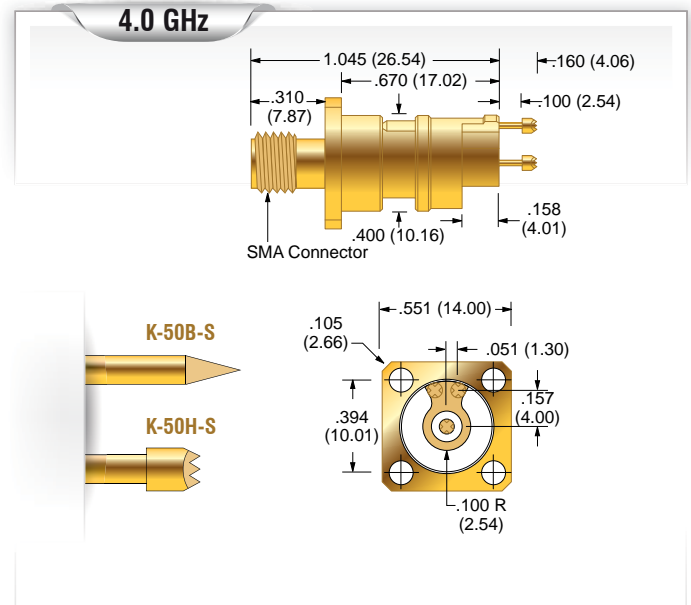
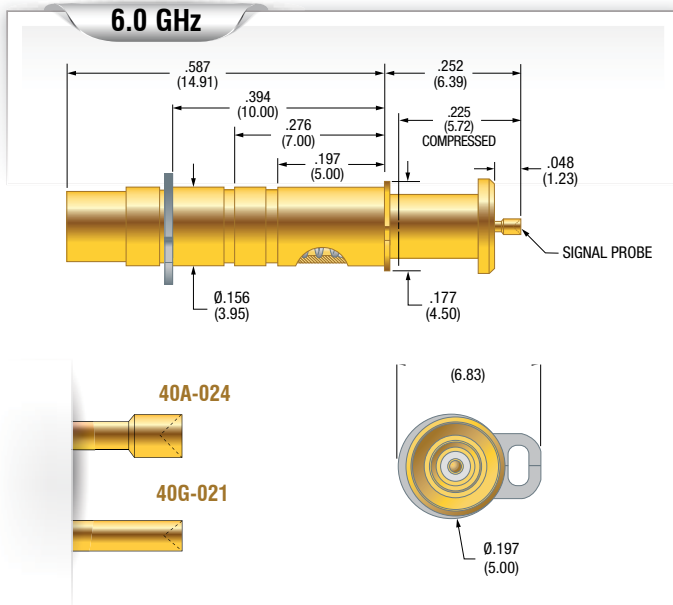

Mechanical

Recommended Travel: 0.133 (3.38) SHIELD, 0.211 (5.36) INCLUDING TRAVEL OF PROBES
 Full Travel: 0.150 (3.81) SHIELD, 0.225 (5.72) INCLUDING TRAVEL OF PROBES
 Operating Temperature: -35°C to +155°C
 Connection: MMCX

Connections, DUT side

CSP-40A-024 MMCX, Fakra, SMB, U.FL
 CSP-40G-021 MMCX, Fakra, SMB, U.FL

Spring Force in oz. (grams)

	Order Code	Preload	Rec. Travel
Standard	CSP-40A-024	0.79 (23.4)	1.75 (49.6)
Standard	CSP-40G-021	0.79 (23.4)	1.75 (49.6)

Electrical (Static Conditions)

Nominal Impedance: 50 Ohms
 Dielectric Voltage Rating: 1K VAC
 Bandwidth @ -1 dB: 6 GHz

Materials and Finishes

Housing: Brass, Gold plated
 Dielectric: Teflon

Replaceable Probes

Order Number (CSP-40A-024): HPA-40A
 Order Number (CSP-40G-021): HPA-40G

Mechanical

Recommended Travel: .090 (2.29)
 Full Travel: .100 (2.54)
 Operating Temperature: -55°C to +105°C
 Connection: Standard SMA Connector

Spring Force in oz. (grams)

	Order Code	Preload	Rec. Travel
Standard	K-50B-S	4.47 (127)	12.00 (340)
Standard	K-50H-S	4.47 (127)	12.00 (340)

Electrical (Static Conditions)

Nominal Impedance: 50 Ohms
 Minimum Return Loss @ 1GHz: 23 dB, 26 dB typical
 Minimum Insertion Loss @ 1GHz: 0.12 dB, 0.06 dB typical
 Maximum VSWR @ 1GHz: 1.15:1, 1.11:1 typical

Materials and Finishes

Housing: Brass, Gold plated
 Dielectric: Premium virgin Teflon per MIL-P-18468

Replaceable Probes

Order Number (K-50B-S): SPL-01B-119
 Order Number (K-50H-S): SPL-01H-116

Applications

The K-50H-S coaxial probe is a shorter version of the K-50 series measurement probe with .100 full travel and a slightly larger mounting flange. Electrical characteristics and applications are similar to the K-50.

K-50L

K-50L-QG

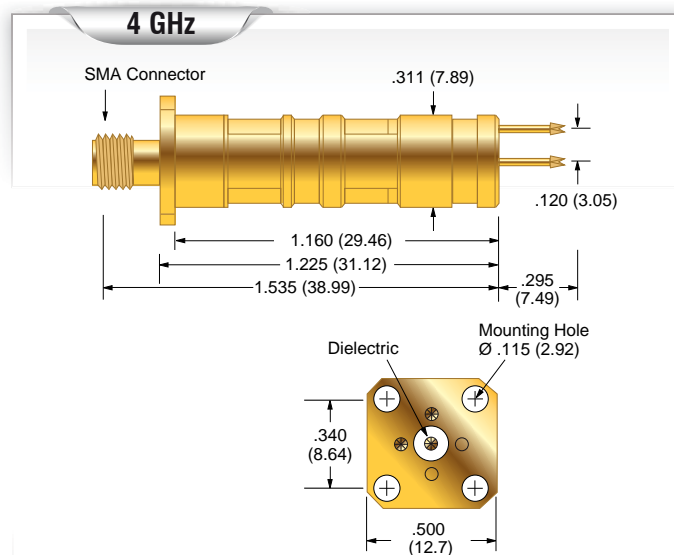
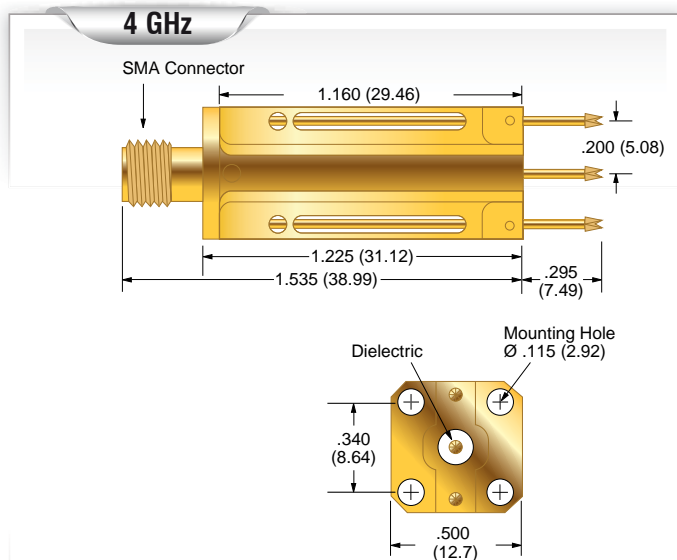

Mechanical

Recommended Travel:	.225 (5.72)
Full Travel:	.250 (6.35)
Operating Temperature:	-55°C to +105°C
Connection:	Standard SMA Connector

Spring Force in oz. (grams)

	Order Code	Preload	Rec. Travel
Standard	K-50L	3.27 (93)	8.13 (231)

Electrical (Static Conditions)

Nominal Impedance:	50 Ohms
Minimum Return Loss @ 1GHz:	23 dB, 26 dB typical
Minimum Insertion Loss @ 1GHz:	0.12 dB, 0.06 dB typical
Maximum VSWR @ 1GHz:	1.15:1, 1.11:1 typical

Materials and Finishes

Housing:	Brass, Gold plated
Dielectric:	Premium virgin Teflon per MIL-P-18468

Replaceable Probes

Order Number:	SPL-01L-039
---------------	-------------

Mechanical

Recommended Travel:	.225 (5.72)
Full Travel:	.250 (6.35)
Operating Temperature:	-55°C to +105°C
Connection:	Standard SMA Connector

Spring Force in oz. (grams)

	Order Code	Preload	Rec. Travel
Standard	K-50L-QG	3.27 (93)	8.13 (231)

Electrical (Static Conditions)

Nominal Impedance:	50 Ohms
Minimum Return Loss @ 1GHz:	23 dB, 26 dB typical
Minimum Insertion Loss @ 1GHz:	0.12 dB, 0.06 dB typical
Maximum VSWR @ 1GHz:	1.15:1, 1.11:1 typical

Materials and Finishes

Housing:	Brass, Gold plated
Dielectric:	Premium virgin Teflon per MIL-P-18468

Replaceable Probes

Order Number:	SPL-01L-039
---------------	-------------

Applications

The K-50 coaxial probe provides an instrumentation-quality interface for broadband R.F. measurements up to 4 GHz. With the K-50 R.F. Circuit Design, impedance characterization measurements can be performed using it as a Network Analyzer port-extending accessory. Accurate and repeatable small signal and R.F. power (50 Watts) measurements provide consistent and repeatable results.

K-50B-QG-75 K-50L-QG-75

K-50B-QG-75R K-50L-QG-75R

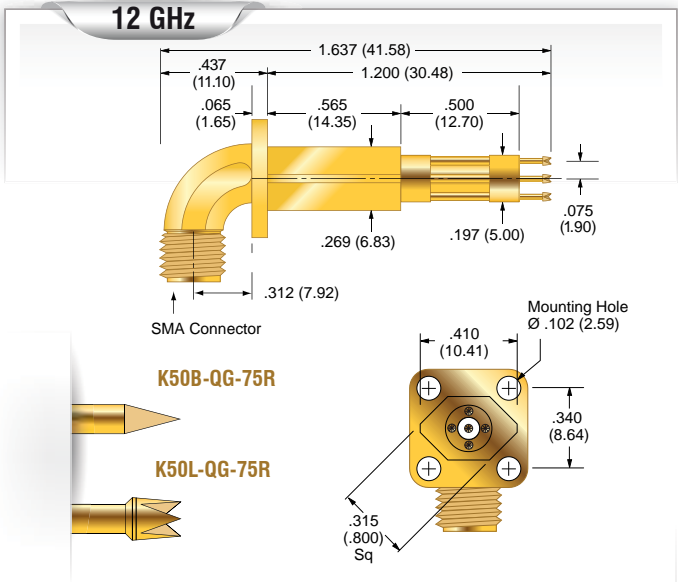
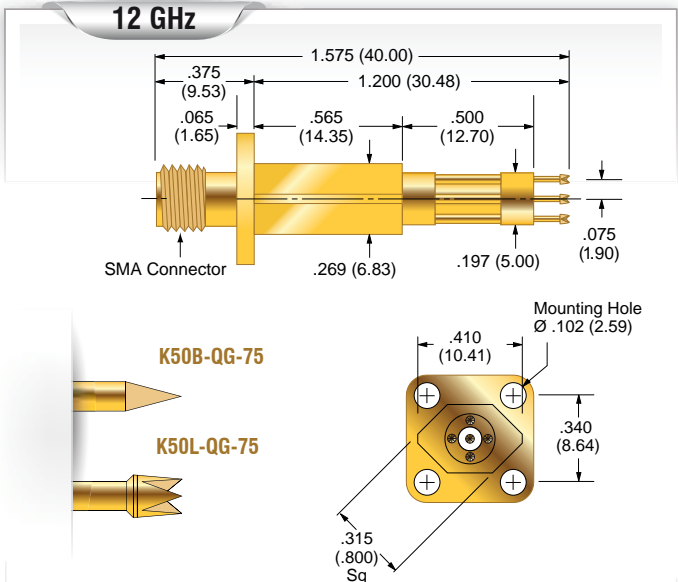

Mechanical

Recommended Travel:	.067 (1.70)
Full Travel:	.100 (2.54)
Operating Temperature:	-55°C to +105°C
Connection:	Standard SMA Connector

Spring Force in oz. (grams)

	Order Code	Preload	Rec. Travel
Standard	K-50B-QG-75	3.74 (106)	14.35 (407)
Standard	K-50L-QG-75	3.74 (106)	14.35 (407)

Electrical (Static Conditions)

Nominal Impedance:	50 Ohms
Minimum Return Loss @ 1GHz:	23.8 dB, 22.8 dB typical
Minimum Return Loss @ 5GHz:	18.3 dB, 16.4 dB typical
Minimum Return Loss @ 10GHz:	17.7 dB, 17.0 dB typical
Minimum Insertion Loss @ 1GHz:	0.183 dB, 0.186 dB typical
Minimum Insertion Loss @ 5GHz:	0.370 dB, 0.371 dB typical
Minimum Insertion Loss @ 10GHz:	0.577 dB, 0.572 dB typical
Maximum VSWR @ 1GHz:	1.14:1, 1.16:1 typical
Maximum VSWR @ 5GHz:	1.28:1, 1.36:1 typical
Maximum VSWR @ 10GHz:	1.30:1, 1.33:1 typical

Materials and Finishes

Housing:	Brass, Gold plated
Dielectric:	Premium virgin Teflon per MIL-P-18468

Replaceable Probes - K-50B-QG-75

Order Number Ground Probe:	HPA-OL
Order Number Signal Probe:	SPG-72L-005

Replaceable Probes - K-50L-QG-75

Order Number Ground Probe:	HPA-OL
Order Number Signal Probe:	SPG-72L-005

Applications

The K-50L-QG-75 series coaxial probe provides an instrumentation-quality interface for broadband R.F. measurements up to 12 GHz. with the K-50L-QG-75 R.F.

Mechanical

Recommended Travel:	.067 (1.70)
Full Travel:	.100 (2.54)
Operating Temperature:	-55°C to +105°C
Connection:	Standard SMA Connector

Spring Force in oz. (grams)

	Order Code	Preload	Rec. Travel
Standard	K-50B-QG-75R	3.74 (106)	14.35 (407)
Standard	K-50L-QG-75R	3.74 (106)	14.35 (407)

Electrical (Static Conditions)

Nominal Impedance:	50 Ohms
Minimum Return Loss @ 1GHz:	25.1 dB, 25.2 dB typical
Minimum Return Loss @ 5GHz:	18.0 dB, 17.5 dB typical
Minimum Return Loss @ 10GHz:	27.0 dB, 35.3 dB typical
Minimum Insertion Loss @ 1GHz:	0.160 dB, 0.159 dB typical
Minimum Insertion Loss @ 5GHz:	0.421 dB, 0.405 dB typical
Minimum Insertion Loss @ 10GHz:	0.489 dB, 0.429 dB typical
Maximum VSWR @ 1GHz:	1.12:1, 1.12:1 typical
Maximum VSWR @ 5GHz:	1.29:1, 1.31:1 typical
Maximum VSWR @ 10GHz:	1.09:1, 1.03:1 typical

Materials and Finishes

Housing:	Brass, Gold plated
Dielectric:	Premium virgin Teflon per MIL-P-18468

Replaceable Probes - K-50B-QG-75R

Order Number Ground Probe:	HPA-OL
Order Number Signal Probe:	SPG-72L-005

Replaceable Probes - K-50L-QG-75R

Order Number Ground Probe:	HPA-OL
Order Number Signal Probe:	SPG-72L-005

Dimensions in inches (millimeters). Specifications subject to change without notice. Consult factory for other temperature requirements, and applications below -40°C. Stocking Disclaimer: Stocking levels for part numbers listed in this catalog are subject to change. Availability is based on current levels of usage and demand.



SWITCH PROBE

A switch probe is a spring contact probe and receptacle that is used to verify the presence of components or connectors. Without compression the switch probe remains open, and after a designated travel the switch probe closes. The most common use for switch probes is in the cable harness testing industry. The switch probe is used to verify the correct location of a terminal contact in a connector while also checking the retention force.

Switch probes also verify the physical presence of non-conductive components such as caps for connectors or devices on a circuit board. There are two separate current paths in a switch probe. The path from the plunger tip to the tail is normally open and closes only after the probe deflects to the designated travel. The second path, from the plunger tip to the outside of the receptacle, is always closed.

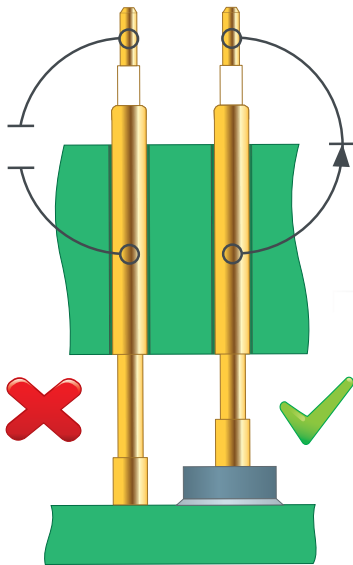

MSP-25C

100 mil (2.54 mm)

MSP-3C

125 mil (3.18 mm)

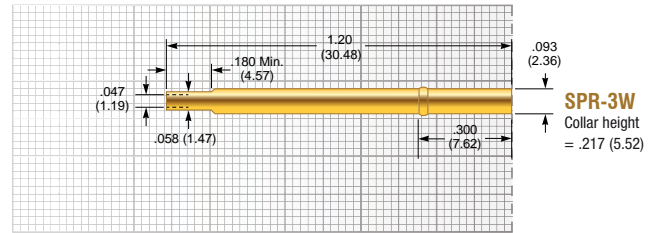
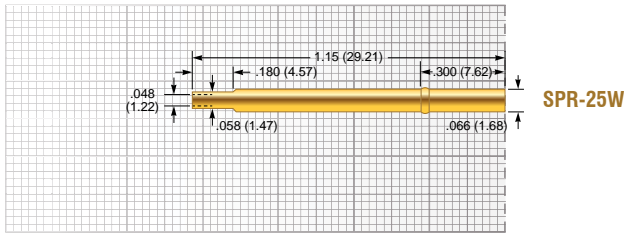
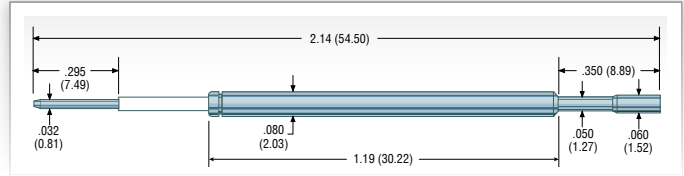
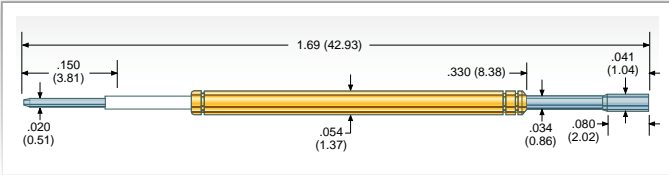

Mechanical

Recommended Travel:	.085 (2.16)
Full Travel:	.125 (3.18)
Switch Point (± .012):	.030 (0.76)
Operating Temperature:	-55°C to +105°C

Spring Force in oz. (grams)

	Switch Point	Rec. Travel
Standard	6.51 (185)	7.55 (212)

Electrical (Static Conditions)

Current Rating:	3 amps
Average Probe Resistance:	<50 mOhms

Materials and Finishes

Plunger:	BeCu, Nickel plated
Barrel:	Work hardened Phosphor Bronze, Gold plated over hard Nickel
Spring:	Music Wire, Silver plated
Insulator:	DELRIN™
Terminal:	BeCu, Silver plated

Mechanical

Recommended Travel:	.085 (2.16)
Full Travel:	.140 (3.56)
Switch Point (± .012):	.030 (0.76)
Operating Temperature:	-55°C to +105°C

Spring Force in oz. (grams)

	Order Code	Switch Point	Rec. Travel
Standard		4.9 (138.9)	6.5 (184.3)
Alternate	- 1	23.3 (660.5)	35.0 (992)

Electrical (Static Conditions)

Current Rating:	3 amps
Average Probe Resistance:	<50 mOhms

Materials and Finishes

Plunger:	BeCu, Nickel plated
Barrel:	Work-hardened Nickel Silver, Silver plated
Spring:	Stainless Steel, Silver plated
Insulator:	KEL-F™
Terminal:	BeCu, Silver plated

Caps for MSP-3C

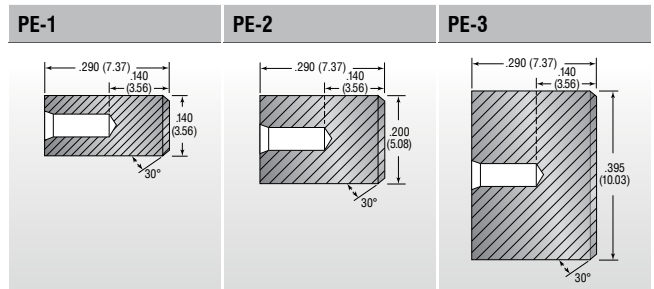

Dimensions in inches (millimeters). Specifications subject to change without notice. Consult factory for other temperature requirements, and applications below -40°C. Stocking Disclaimer: Stocking levels for part numbers listed in this catalog are subject to change. Availability is based on current levels of usage and demand.



SPL-03C-069

125 mil (3.18 mm)

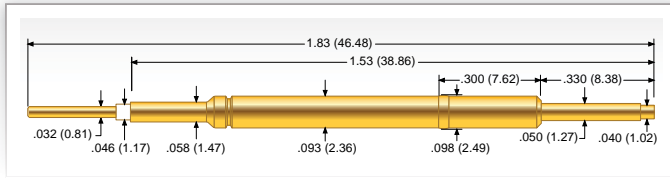

SSP-5C

187 mil (4.75 mm)

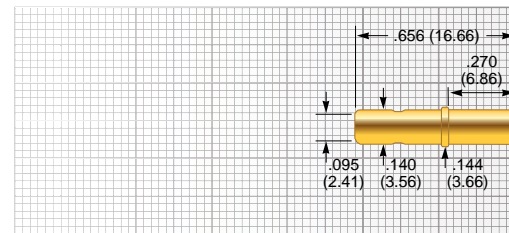
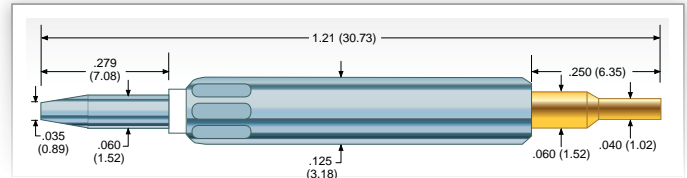

SSR-5Y

Mechanical

Recommended Travel:	.167 (4.24)
Full Travel:	.330 (8.38)
Switch Point (± .012):	.025 (0.64)
Operating Temperature:	-55°C to +105°C

Spring Force in oz. (grams)

	Switch Point	Rec. Travel
Standard	3.2 (91)	1.85 (52)

Electrical (Static Conditions)

Current Rating:	3 amps
Average Probe Resistance:	<50 mOhms

Materials and Finishes

Plunger:	BeCu, Gold plated
Barrel:	Nickel Silver, Gold plated
Spring:	Music Wire
Insulator:	DELRIN™
Terminal:	BeCu, Gold plated

Mechanical

Recommended Travel:	.100 (2.54)
Full Travel:	.150 (3.81)
Switch Point (± .012):	.025 (0.64)
Operating Temperature:	-55°C to +150°C

Spring Force in oz. (grams)

	Switch Point	Rec. Travel
Standard	2.36 (66)	4.5 (128)

Electrical (Static Conditions)

Current Rating:	5 amps
Average Probe Resistance:	<50 mOhms

Materials and Finishes

Plunger:	BeCu, Gold plated
Barrel:	Nickel Silver, Silver plated
Spring:	Spring Steel, Silver plated
Insulator:	DELRIN™
Terminal:	BeCu, Gold plated

MSP-5C

187 mil (4.75 mm)

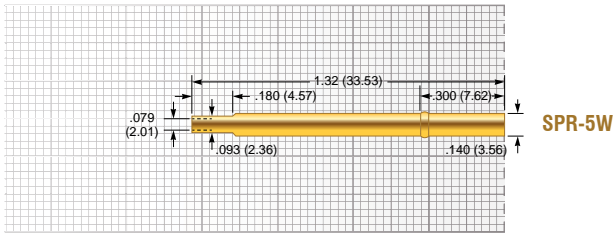
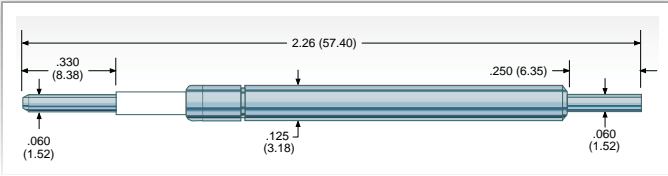

Mechanical

Recommended Travel:	.132 (3.35)
Full Travel:	.185 (4.70)
Switch Point ($\pm .012$):	.025 (0.64)
Operating Temperature:	-55°C to +105°C

Spring Force in oz. (grams)

Order Code	Switch Point	Rec. Travel
Standard	2.5 (70)	5.2 (146)
Alternate - 1	26.9 (755)	35.0 (992)

Electrical (Static Conditions)

Current Rating:	5 amps
Average Probe Resistance:	<20 mOhms

Materials and Finishes

Plunger:	Brass, Nickel plated
Barrel:	Brass, Silver plated
Spring:	Stainless Steel, Silver plated
Insulator:	KEL-F™
Terminal:	Brass, Silver plated

STEP PROBE

A “Step” or “hat” probes are designed to control the distance of probe tip entry into a wire harness connector housing, thus allowing electrical contact to be made to a terminal without actually entering the terminal. The critical areas of the connector terminal remain virgin to assure proper conductivity and intermetallic relationships once the harness is assembled into its end use.

Depending on customer preference, step probes can be replaceable or permanent. All replaceable step probes feature a Pylon Bend, to prevent walkout of the probes from the receptacle. Non-replaceable probes have a press ring, which holds the probe in place and keeps it from walking out of the mounting bracket.

Though used almost exclusively in the wire harness testing industry step probes can also be used in ICT/FCT testing. ECT offers a variety of pitches and step depths to accommodate most harness test requirements.

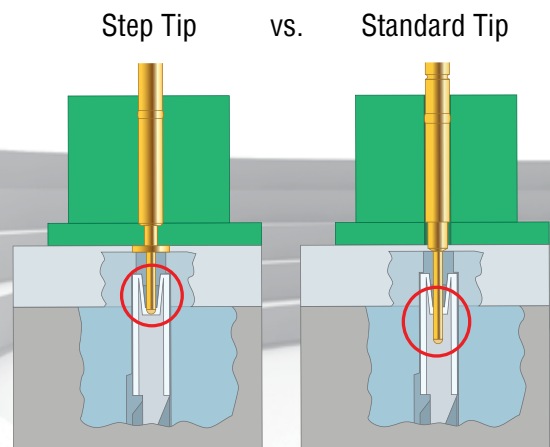
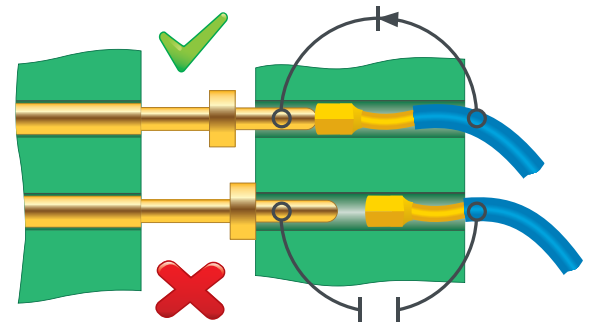

STP-1

75 mil (1.91 mm)

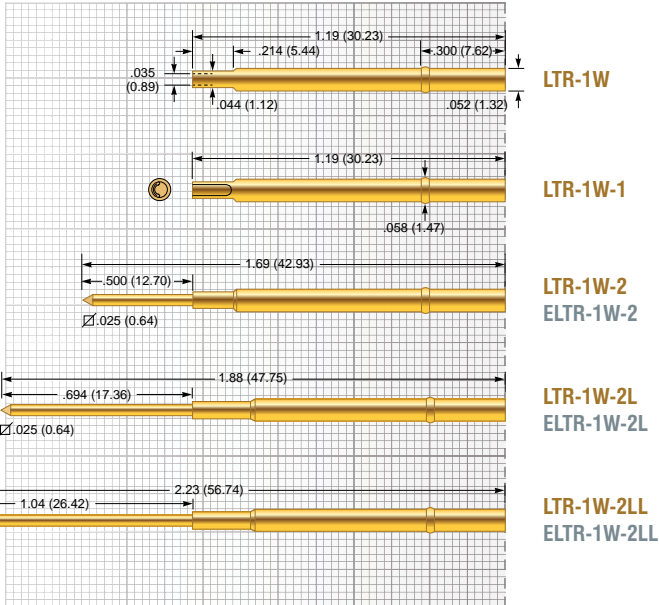
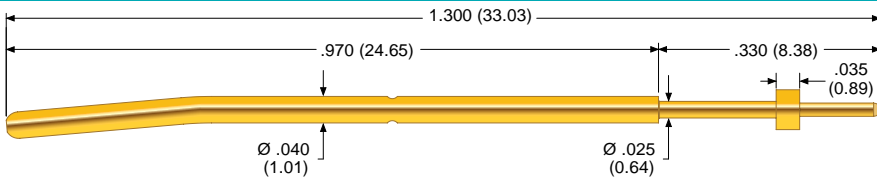

Mechanical

Recommended Travel: .120 (3.05)
 Full Travel: min. .135 (3.43)
 Operating Temperature: -55°C to +150°C

Spring Force in oz. (grams)

	Order Code	Preload	Rec. Travel
Standard		1.5 (43)	2.9 (82)

Electrical (Static Conditions)

Current Rating: 3 amps
 Average Probe Resistance: <35 mOhms

Materials and Finishes

Plunger: Heat-treated BeCu, Gold plated over hard Nickel or Rhodium plated
 Barrel: Work-hardened Phosphorous Bronze, Gold plated over hard Nickel
 Spring: Stainless Steel, Silver plated

Receptacle

Hole diameter: Ø .053 to .055 (1.35 to 1.40)
 Suggested drill: #54 or 1.40 mm
 Material
 • LTR Housing: Work-hardened Nickel Silver, Gold plated over hard Nickel
 • ELTR Housing: Nickel Silver, unplated
 Post: Phosphorous Bronze, Gold plated

Gold plated Tip Style

J120-3G	J140-3G	J160-3G	
Ø .020 (0.51)	Ø .020 (0.51)	Ø .020 (0.51)	

Rhodium plated Tip Style

J120-3R	J140-3R	J160-3R	
Ø .020 (0.51)	Ø .020 (0.51)	Ø .020 (0.51)	

	Series	Size	Tip Style	Plating
Gold	STP	1	J120	3G
Rhodium	STP	1	J120	3R

Dimensions in inches (millimeters). Specifications subject to change without notice. Consult factory for other temperature requirements, and applications below -40°C. Stocking Disclaimer: Stocking levels for part numbers listed in this catalog are subject to change. Availability is based on current levels of usage and demand.



ECT CONTACT PRODUCTS
 A CoNu Company
 ECT-CPG.com
 shop.ECT-CPG.com

STP-25

100 mil (2.54 mm)

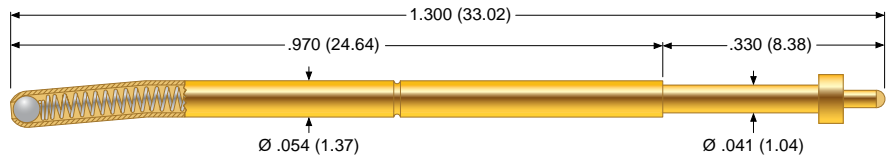

Mechanical

Recommended Travel: .120 (3.05)
 Full Travel: min. .135 (3.43)
 Operating Temperature: -55°C to +150°C

Spring Force in oz. (grams)

	Preload	Rec. Travel
STP-25	1.5 (43)	2.9 (82)

Electrical (Static Conditions)

Current Rating: 5 amps
 Average Probe Resistance: <35 mOhms

Materials and Finishes

Plunger: Heat-treated BeCu, Gold plated over hard Nickel or Rhodium plated
 Barrel: Work-hardened Nickel Silver, Gold plated
 Spring: Stainless Steel, Silver plated

Receptacle

Hole diameter: Ø .067 to .069 (1.70 to 1.75)
 Suggested drill: #51 or 1.70 mm
 Material
 • SPR Housing: Work-hardened Nickel Silver, Gold plated over hard Nickel
 • EPR Housing: Nickel Silver, unplated
 Post: Phosphorous Bronze, Gold plated

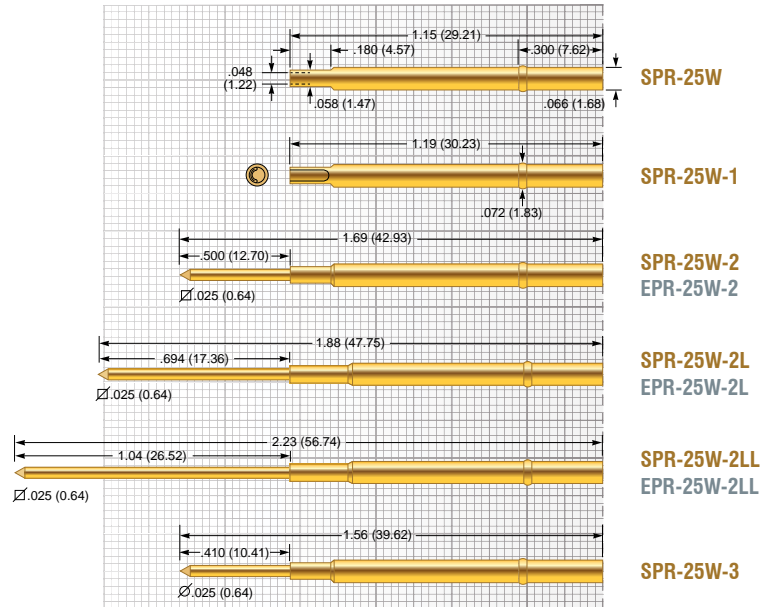

Gold plated Tip Style

C060-3G	J060-3G	J080-3G	J100-3G	J140-3G	J160-3G
Ø .030 (0.76)	Ø .025 (0.64)	Ø .025 (0.64)	Ø .025 (0.64)	Ø .025 (0.64)	Ø .025 (0.64)

Rhodium plated Tip Style

C060-3R	J060-3R	J080-3R	J100-3R	J140-3R	J160-3R
Ø .030 (0.76)	Ø .025 (0.64)	Ø .025 (0.64)	Ø .025 (0.64)	Ø .025 (0.64)	Ø .025 (0.64)

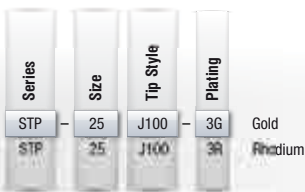

SPL-03

125 mil (3.18 mm)

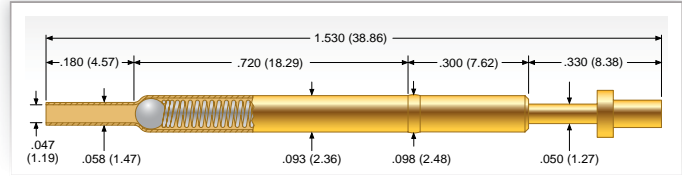

Mechanical

Recommended Travel:

- SPL-03C-114 / -153 .127 (3.23)
- SPL-03C-090 .220 (5.59)

Operating Temperature

- SPL-03C-090 -55°C to +105°C
- SPL-03C-114 / -153 -55°C to +85°C

Spring Force in oz. (grams)

	Preload	Rec. Travel
SPL-03C-090	0.8 (23)	2.3 (65)
SPL-03C-114	1.7 (48)	4.0 (113)
SPL-03C-153	1.6 (45)	4.0 (113)

Electrical (Static Conditions)

- Current Rating: 6 amps
- Average Probe Resistance: < 50 mOhms

Materials and Finishes

- Plunger: Heat-treated BeCu, Gold plated over hard Nickel
Heat-treated BeCu, Rhodium plated over hard Nickel
- Barrel: Work-hardened Phosphor Bronze or Nickel Silver, Gold plated over hard Nickel
- Spring: Music Wire, Silver plated or BeCu, Silver plated
- Ball: Hardened Brass or hardened Brass, Gold plated

Mounting Options

- Hole diameter: Ø .094 to .096 (2.39 to 2.44)
- Recommended wire gauge: 22-26 AWG
- Recommended drill size: #41 or 2.40 mm

Gold plated Tip Style

C-090	C-114		
Ø .030 (0.76)	Ø .070 (1.78)		

Rhodium plated Tip Style

C-153			
Ø .060 (1.52)			
Rec. Travel .220 (5.59)			

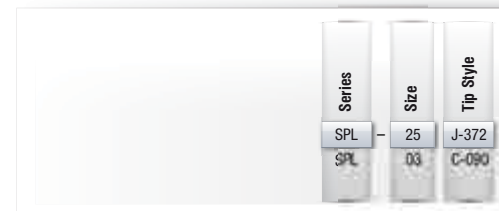

Dimensions in inches (millimeters). Specifications subject to change without notice. Consult factory for other temperature requirements, and applications below -40°C. Stocking Disclaimer: Stocking levels for part numbers listed in this catalog are subject to change. Availability is based on current levels of usage and demand.



BATTERY PROBE

Battery probes are typically contained in modules where consistent long-life, low-resistance, electrical and mechanical connections are required. ECT battery probes offer superior durability in high cycle life applications compared to leaf spring applications. Pogo based solutions can maintain consistent electro-mechanical characteristics in excess of mission cycles. When mating planar tolerances pose a challenge or a longer reach is required, spring probes are the preferred solution.

Battery probes are typically molded into a housing and soldered either to mating PCB or terminal to provide a permanent stable and reliable electrical and mechanical connection.

Everett Charles Technologies versatile line of battery interconnect probes gives you design flexibility to match your performance, cost, and assembly requirements. Our design expertise and complete manufacturing capabilities will help you bring your product to market quickly and easily. As part of our customer service commitment, these products can be modified or custom designed to meet your needs. Contact us to discuss the limitless possibilities.



BIP-1 BIP-3

BIP-2 BIP-8

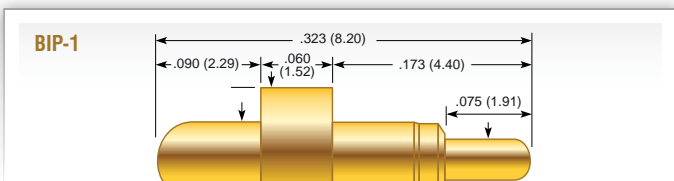

Mechanical

Recommended Travel: .050 (1.27)
 Full Travel: .075 (1.91)
 Operating Temperature: -55°C to +150°C

Spring Force in oz. (grams)

	Preload	Rec. Travel
Standard	1.18 (33)	3.25 (92)

Electrical (Static Conditions)

Current Rating: 5 amps
 Average Probe Resistance: <16 mOhms

Materials and Finishes

Plunger: BeCu, Gold plated over hard Nickel
 Barrel: Brass, Gold plated over hard Nickel
 Spring: Stainless Steel, Silver plated

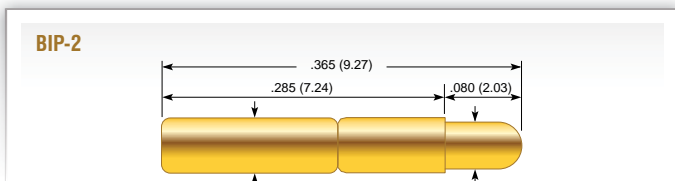

Mechanical

Recommended Travel: .050 (1.27)
 Full Travel: .050 (1.27)
 Operating Temperature: -55°C to +150°C

Spring Force in oz. (grams)

	Preload	Rec. Travel
Standard	1.10 (31)	3.85 (109)

Electrical (Static Conditions)

Current Rating: 5 amps
 Average Probe Resistance: <30 mOhms

Materials and Finishes

Plunger: Heat-treated BeCu, Gold plated over hard Nickel
 Barrel: Work-hardened Nickel Silver, Gold plated over hard Nickel
 Spring: Stainless Steel, Silver plated

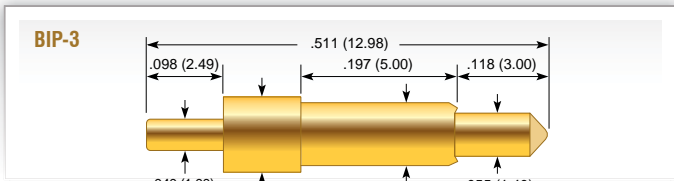

Mechanical

Recommended Travel: .060 (1.52)
 Full Travel: .100 (2.54)
 Operating Temperature: -55°C to +105°C

Spring Force in oz. (grams)

Order Code	Preload	Rec. Travel
Standard	0.30 (8.5)	1.06 (30)
Alternate -1	1.1 (31)	3.40 (86)

Electrical (Static Conditions)

Current Rating: 5 amps
 Average Probe Resistance: <30 mOhms

Materials and Finishes

Plunger: Brass, Gold plated over hard Nickel
 Barrel: Brass, Gold plated over hard Nickel
 Spring: Music Wire, Silver plated

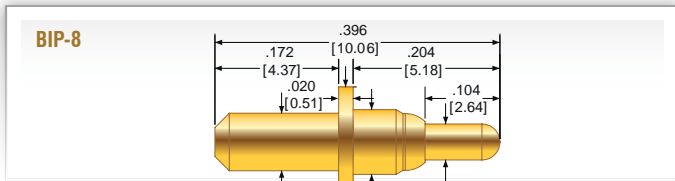

Mechanical

Recommended Travel: .060 (1.52)
 Full Travel: .090 (2.29)
 Operating Temperature: -55°C to +150°C

Spring Force in oz. (grams)

	Preload	Rec. Travel
Standard	2.40 (68.0)	6.20 (176)

Electrical (Static Conditions)

Current Rating: 5 amps
 Average Probe Resistance: <30 mOhms

Materials and Finishes

Plunger: BeCu, Gold plated
 Barrel: BeCu, Gold plated
 Spring: Stainless Steel, Gold plated
 Ball: Stainless Steel

Dimensions in inches (millimeters). Specifications subject to change without notice. Consult factory for other temperature requirements, and applications below -40°C. Stocking Disclaimer: Stocking levels for part numbers listed in this catalog are subject to change. Availability is based on current levels of usage and demand.



BIP-10

BIP-12

BIP-10

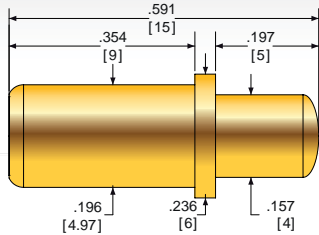

Mechanical

Recommended Travel: .126 (3.20)
 Full Travel: .157 (4.00)
 Operating Temperature: -40°C to +80°C

Spring Force in oz. (grams)

	Preload	Rec. Travel
Standard	1.00 (28.3)	5.40 (153)

Electrical (Static Conditions)

Current Rating: 5 amps
 Average Probe Resistance: <30 mOhms, Steel, Gold plated
 <100 mOhms, Stainless Steel

Materials and Finishes

Plunger: Brass, Gold plated
 Barrel: Brass, Gold plated
 Spring: Stainless Steel, Silver plated

Receptacle

Hole Diameter: 0.221 to 0.228 (5.61 to 5.79)
 Suggested drill: #2 or #1
 Material Housing: Brass, Gold plated

BIP-12

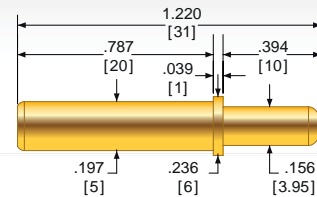

Mechanical

Recommended Travel: .315 (8.00)
 Full Travel: .394 (10.00)
 Operating Temperature: -40°C to +80°C

Spring Force in oz. (grams)

	Preload	Rec. Travel
Standard	0.87 (24.7)	5.40 (153)

Electrical (Static Conditions)

Current Rating: 5 amps
 Average Probe Resistance: <30 mOhms, Steel, Gold plated
 <100 mOhms, Stainless Steel

Materials and Finishes

Plunger: BeCu, Gold plated
 Barrel: Brass, Gold plated
 Spring: Stainless Steel, Silver plated

Receptacle

Hole Diameter: 0.221 to 0.228 (5.61 to 5.79)
 Suggested drill: #2 or #1
 Material Housing: Brass, Gold plated

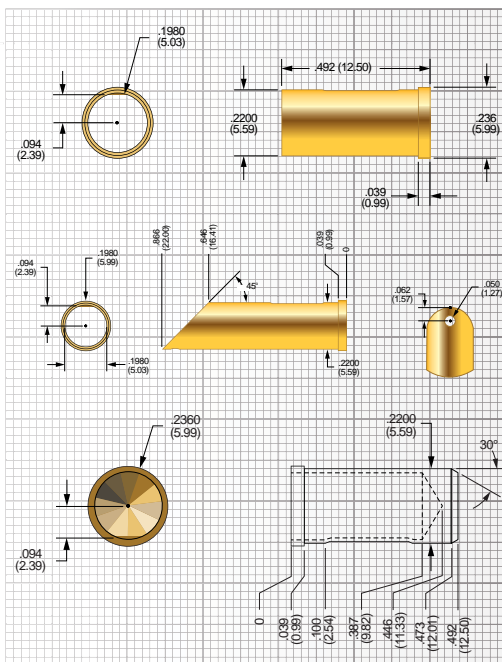

BIR-9W

BIR-9W-1

BIR-9Y

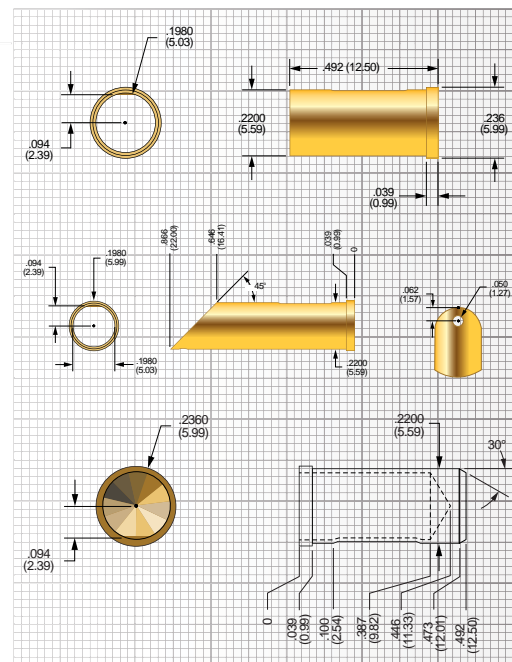

BIR-9W

BIR-9W-1

BIR-9Y



CCA-003 CCA-004

CCA-006

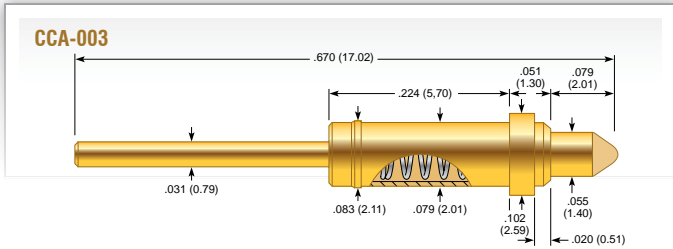

Mechanical

Recommended Travel: .040 (1.02)
 Full Travel: .078 (1.98)
 Operating Temperature: -35°C to +105°C

Spring Force in oz. (grams)

	Preload	Rec. Travel
Standard	1.27 (36.0)	2.94 (83.0)

Electrical (Static Conditions)

Current Rating: 10 amps
 Average Probe Resistance: <50 mOhms

Materials and Finishes

Plunger: Brass, Gold plated
 Barrel: Brass, Gold plated
 Spring: Music Wire, Gold plated

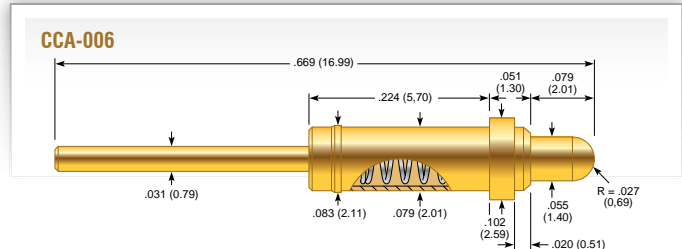

Mechanical

Recommended Travel: .040 (1.02)
 Full Travel: .078 (1.98)
 Operating Temperature: -35°C to +105°C

Spring Force in oz. (grams)

	Preload	Rec. Travel
Standard	1.24 (35.0)	2.94 (85.0)

Electrical (Static Conditions)

Current Rating: 5 amps
 Average Probe Resistance: <50 mOhms

Materials and Finishes

Plunger: Brass, Gold plated
 Barrel: Brass, Gold plated
 Spring: Music Wire, Gold plated

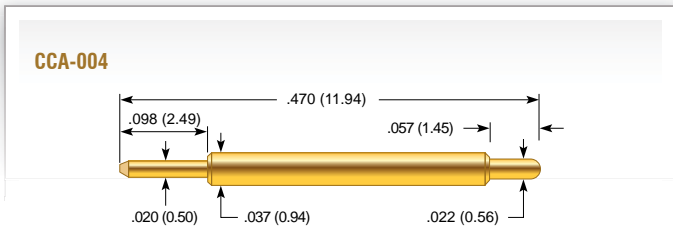

Mechanical

Recommended Travel: .040 (1.02)
 Full Travel: .057 (1.45)
 Operating Temperature: -35°C to +105°C

Spring Force in oz. (grams)

	Preload	Rec. Travel
Standard	0.83 (24.0)	2.85 (81.0)

Electrical (Static Conditions)

Current Rating: 10 amps
 Average Probe Resistance: <50 mOhms

Materials and Finishes

Plunger: Brass, Gold plated
 Barrel: Brass, Gold plated
 Spring: Music Wire, Gold plated

Dimensions in inches (millimeters). Specifications subject to change without notice. Consult factory for other temperature requirements, and applications below -40°C. Stocking Disclaimer: Stocking levels for part numbers listed in this catalog are subject to change. Availability is based on current levels of usage and demand.



CP-059-019 CP-059-025

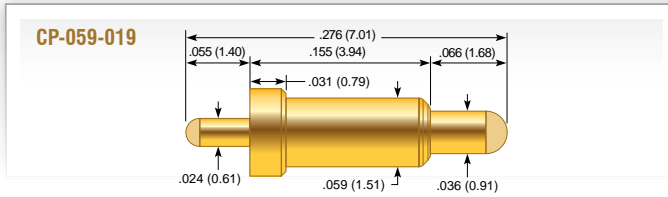

Mechanical

Recommended Travel:	.040 (1.02)
Full Travel:	.062 (1.57)
Operating Temperature:	-55°C to +150°C

Spring Force in oz. (grams)

	Preload	Rec. Travel
Standard	1.63 (46.0)	4.50 (128)

Electrical (Static Conditions)

Current Rating:	10 amps
Average Probe Resistance:	<25 mOhms

Materials and Finishes

Plunger:	Brass, Gold plated
Barrel:	Brass, Gold plated
Spring:	Stainless Steel, Gold plated

CP-059-026

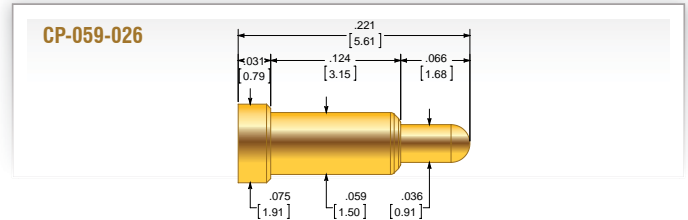

Mechanical

Recommended Travel:	.040 (1.02)
Full Travel:	.057 (1.45)
Operating Temperature:	-55°C to +150°C

Spring Force in oz. (grams)

	Preload	Rec. Travel
Standard	0.81 (23.0)	4.50 (128)

Electrical (Static Conditions)

Current Rating:	10 amps
Average Probe Resistance:	<25 mOhms

Materials and Finishes

Plunger:	Brass, Gold plated
Barrel:	Brass, Gold plated
Spring Standard:	Stainless Steel, Gold plated

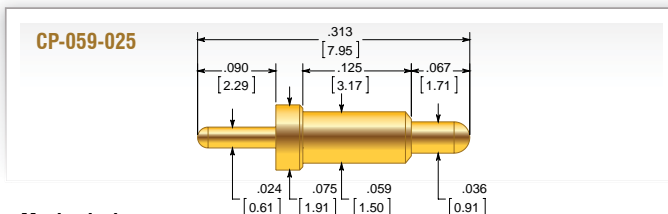

Mechanical

Recommended Travel:	.040 (1.02)
Full Travel:	.057 (1.45)
Operating Temperature:	-55°C to +150°C

Spring Force in oz. (grams)

	Preload	Rec. Travel
Standard	0.81 (23.0)	4.50 (128)

Electrical (Static Conditions)

Current Rating:	10 amps
Average Probe Resistance:	<25 mOhms

Materials and Finishes

Plunger:	Brass, Gold plated over hard Nickel
Barrel:	Brass, Gold plated over hard Nickel
Spring:	Stainless Steel, Gold plated

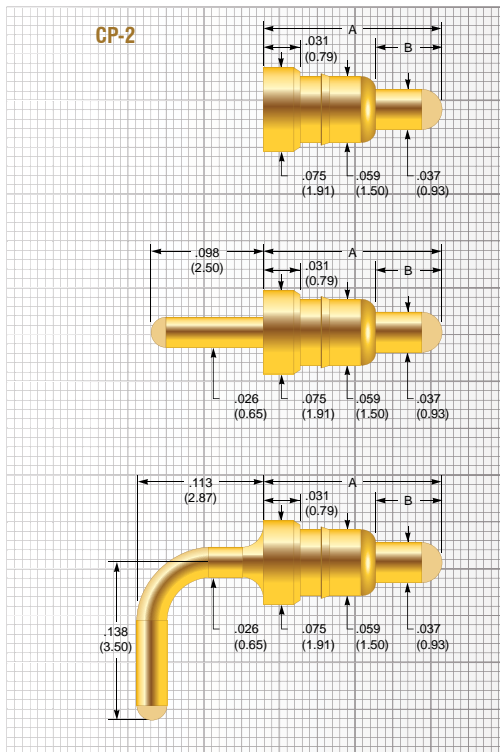

CP-2SB-X

CP-2TB-X

CP-2LB-X

Mechanical

	Size 4	Size 6	Size 8	Size 12
Recommended Travel:	0.030 (0.75)	0.059 (1.50)	0.079 (2.00)	0.118 (3.00)
Full Travel:	0.039 (1.00)	0.069 (1.75)	0.089 (2.25)	0.128 (3.25)
Operating Temperature:	-55°C to +155°C			

Spring Force in oz. (grams)

	Size 4	Size 6	Size 8	Size 12
Preload	0.66 (18.7)	1.32 (37.4)	1.17 (33.3)	0.95 (26.9)
Rec. Travel	4.5 (127.6)	4.5 (127.6)	4.5 (127.6)	4.5 (127.6)

Mechanical

Dimension A	0.158 (4.00)	0.236 (6.00)	0.315 (8.00)	0.472 (12.00)
Dimension B	0.059 (1.50)	0.087 (2.20)	0.114 (2.90)	0.169 (4.30)

Electrical (Static Conditions)

Current Rating	5 A
Average Probe Resistance	50 mOhms

Materials and Finishes

Plunger:	BeCu, Gold plated
Barrel:	Brass, Gold plated
Spring:	Stainless Steel

CP-4

Mechanical

Recommended Travel: .040 (1.01)
 Full Travel: .060 (1.52)
 Operating Temperature: -55°C to +150°C

Spring Force in oz. (grams)

	Preload	Rec. Travel
Standard	0.49 (13.89)	2.50 (70.87)

Electrical (Static Conditions)

Current Rating: 10 amps
 Average Probe Resistance: <25 mOhms

Materials and Finishes

Plunger: BeCu, Gold plated
 Barrel: Brass, Gold plated
 Spring: Stainless Steel, Gold plated
 Ball: Stainless Steel

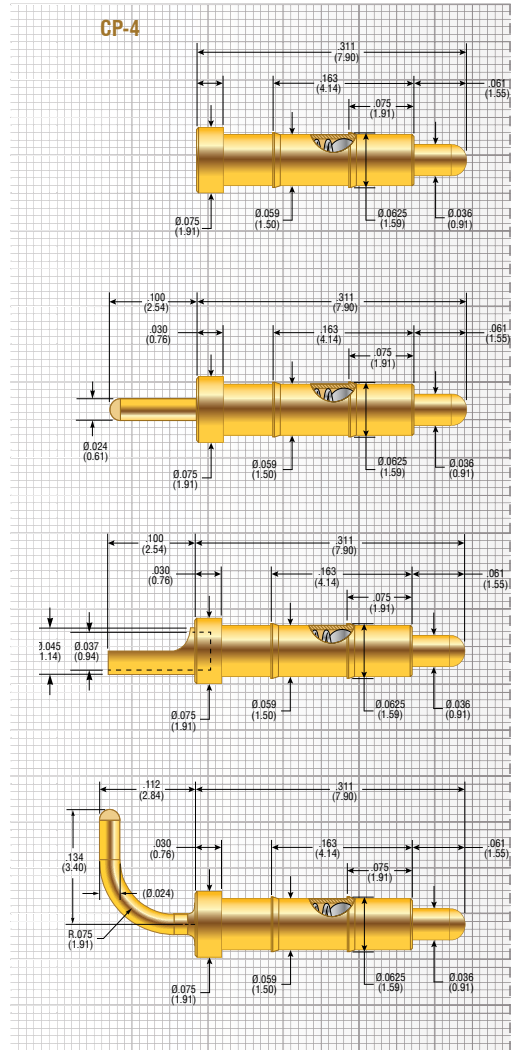

CP-4S

CP-4T

CP-4C

CP-4L

SEMICONDUCTOR PROBE

ECT has a long history manufacturing single-ended and double-ended fine pitch probes.

Thanks to our large market exposure at most major semiconductor producers, we have gained substantial expertise from our worldwide customer base. This expertise is reflected in each new probe series we develop, allowing us to stay a head of the very technically demanding semiconductor market.

Please feel free to contact us for further requirements or more information, as we can meet a variety of special requirements including ultra-high temperature applications or non-magnetic probes for the MEMS market.

The ZIP® Advantage

ECT's ZIP® series feature a number of innovative designs that provide superior contact capable of meeting your application needs. Utilizing ECT's patented flat technology, ZIP semiconductor spring probes present a new level of accuracy, scalability, and performance. While conventional round technology restricts longer travel and can have its reliability undermined by its small contact area, ZIP possesses a large internal contact area, resulting in low C-Res, superior bandwidth, and excellent high current behavior. The performance, economy, and application versatility provided by ZIP probes are further enhanced by the use of an external spring. Conventional spring probes rely on contact between the barrel and plunger, which allows for the possibility of conductivity interference through contamination build up in dirty test environments. By having an external spring and no barrel, ZIP greatly reduces the threat of contamination, thereby reducing cost-of-test and increasing efficiency. ECT has produced flat compliant contacts since 1995. The ZIP series is the culmination of years of experience and development, and reflects the industry's finest semiconductor contacts. With its broad scope of application solutions and special options, the ZIP family of products can satisfy all of your semiconductor test needs. If your spring probes aren't meeting your tough, high volume challenges, then you don't know ZIP.

Bantam® Series

The Bantam® probe is a high-performance, spring loaded compliant contact for applications requiring robust, short contact to support fine pitch and high bandwidth production needs. Unlike conventional spring probes, the Bantam has only one internal sliding / wiping contact surface, providing consistent low resistance levels while maintaining a high level of Z-Axis compliance.

CSP and SPLJ Series

These probes are traditional but state of the art double ended probes ranging from 0.4mm to 1.27mm pitch. The CSP probe series offers a selection of different plating options to optimize contact challenges and maximize probe life. Various length options also allow drop-in replacement capability for most competitor probes.

Mini-Mite™ Series

The SCP or Mini-Mite™ probe features a unique single ended design, providing very low, consistent DC resistance. The uniform design allows all three product pitches to be used on the same test height. The single sliding contact cuts the failure mode in half and ensures highly repeatable results.

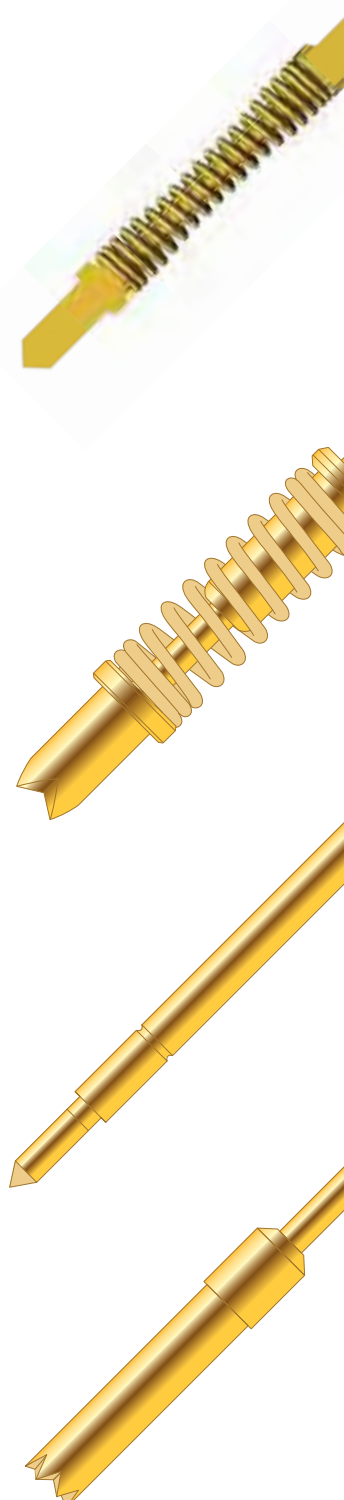

ZO

0.40 mm, 0.50 mm

Ultra HIGH Bandwidth

The ZO Ultra High Bandwidth Series takes advantage of the ZIP® scalable architecture to arrive at an ultra-compact design with 0.50 nH and 0.60 nH inductance. ZO offers a bandwidth of 30GHz and 40GHz, making ZO an ideal solution for high frequency testing.

ZO-040

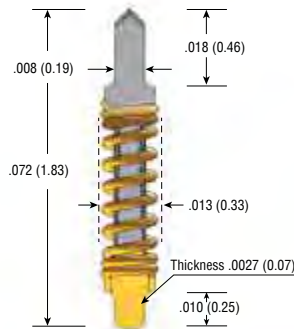

Mechanical

Pitch:	.016 (0.40)
Recommended Travel:	.018 (0.46)
Full Travel:	.020 (0.50)
Test Height:	.059 (1.51)
Mechanical Life*:	200,000 cycles
Operating Temperature:	-55°C to +155°C

Spring Force in oz. (grams)

	Order Code	Test Height
Standard		0.66 (19)
High	- 1	0.96 (27)

Electrical (Static Conditions)

Current Rating DC:	2.5 amps
Average DC Probe Resistance**:	<90 mOhms
Self Inductance (Ls):	0.50 nH
Capacitance (Cc):	0.030 pF
Bandwidth @ -1dB:	> 30.0 GHz

Materials and Finishes

Plunger DUT:	HyperCore™
Plunger HIB:	BeCu, Gold plated over hard Nickel
Spring:	Stainless Steel, Gold plated

Tip Style - DUT



Tip Style - HIB

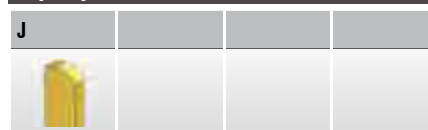

ZO-050

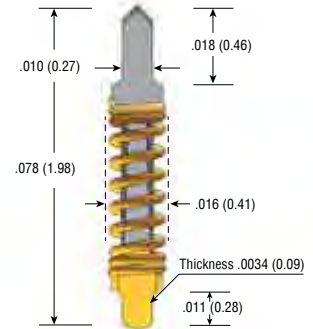

Mechanical

Pitch:	.020 (0.50)
Recommended Travel:	.019 (0.48)
Full Travel:	.022 (0.56)
Test Height:	.059 (1.51)
Mechanical Life*:	500,000 cycles
Operating Temperature:	-55°C to +155°C

Spring Force in oz. (grams)

	Order Code	Test Height
Standard		0.65 (18)
High	- 1	1.11 (31)

Electrical (Static Conditions)

Current Rating DC:	2.88 amps
Average DC Probe Resistance** :	<90 mOhms
Self Inductance (Ls):	0.60 nH
Capacitance (Cc):	0.03 pF
Bandwidth @ -1dB:	> 40.0 GHz

Materials and Finishes

Plunger DUT:	HyperCore™
Plunger HIB:	BeCu with proprietary plating
Spring:	Stainless Steel, Gold plated

Tip Style - DUT



Tip Style - HIB



* Life specifications are based on lab results but are dependent on cleaning frequency and the specific customer application, including DUT materials, handler kit, maintenance, etc.
 ** Contact resistance will increase over time due to solder build-up and wear



Z-040

0.40 mm

Z-040

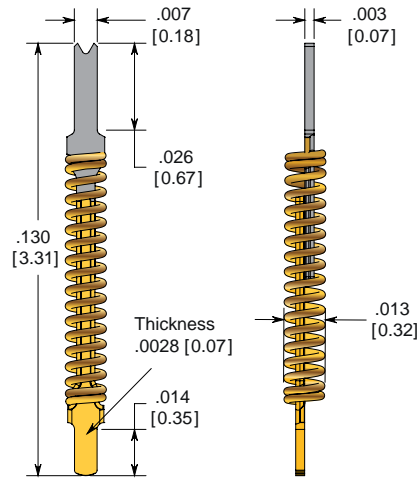

Mechanical

Pitch:	.016 (0.40)
Recommended Travel:	.025 (0.64)
Full Travel:	.028 (0.71)
Test Height:	.105 (2.67)
Mechanical Life*:	500,000 cycles
Operating Temperature:	-55°C to +155°C
Spring Force in oz. (grams):	1.20 (34)

Electrical (Static Conditions)

Current Rating DC:	2.0 amps
Average DC Probe Resistance** :	< 85 mOhms
Self Inductance (Ls):	1.07 nH
Capacitance (Cc):	0.21 pF
Bandwidth @ -1dB:	30.0 GHz

Materials and Finishes

Plunger DUT:	HyperCore™
Plunger HIB:	BeCu with proprietary plating
Spring:	Stainless Steel, Gold plated

HIGH Bandwidth

The ZIP® Z High Bandwidth Series yields the highest and most stable bandwidth for its package size. The high performance provided by these contacts makes the Z series a perfect choice for the most demanding test applications. High Bandwidth probes are available in 0.4mm and 0.5mm pitches.

Tip Style - DUT HyperCore



Tip Style - HIB



HYPERcore™
[base material]



* Life specifications are based on lab results but are dependent on cleaning frequency and the specific customer application, including DUT materials, handler kit, maintenance, etc.
** Contact resistance will increase over time due to solder build-up and wear

Dimensions in inches (millimeters). Specifications subject to change without notice. Consult factory for other temperature requirements, and applications below -40°C. Stocking Disclaimer: Stocking levels for part numbers listed in this catalog are subject to change. Availability is based on current levels of usage and demand.



ECT CONTACT PRODUCTS
A CoNu Company
ECT-CPG.com
shop.ECT-CPG.com

Z-050

0.50 mm

HIGH Bandwidth

The ZIP® Z High Bandwidth Series yields the highest and most stable bandwidth for its package size. The high performance provided by these contacts makes the Z series a perfect choice for the most demanding test applications. High Bandwidth probes are available in 0.4mm and 0.5mm pitches.

Z-050

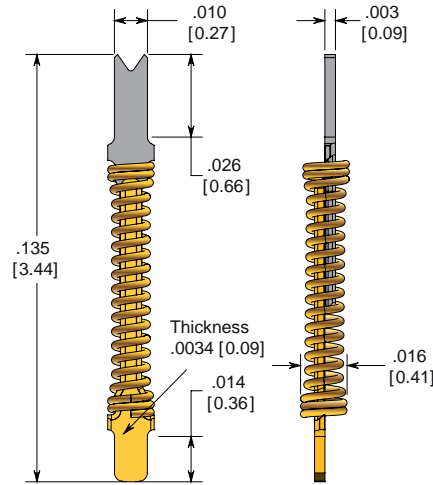

Mechanical

Pitch:	.020 (0.50)
Recommended Travel:	.025 (0.64)
Full Travel:	.030 (0.76)
Test Height:	.110 (2.79)
Mechanical Life*:	500,000 cycles
Operating Temperature:	-55°C to +155°C
Spring Force in oz. (grams):	1.40 (40)

Electrical (Static Conditions)

Current Rating DC:	2.8 amps
Average DC Probe Resistance** :	<65 mOhms
Self Inductance (Ls):	1.01 nH
Capacitance (Cc):	0.20 pF
Bandwidth @ -1dB:	25.0 GHz

Materials and Finishes

Plunger DUT:	HyperCore™
Plunger HIB:	BeCu with proprietary plating
Spring:	Stainless Steel, Gold plated

Tip Style - DUT HyperCore



Tip Style - HIB



HYPERcore™
[base material]



* Life specifications are based on lab results but are dependent on cleaning frequency and the specific customer application, including DUT materials, handler kit, maintenance, etc.
** Contact resistance will increase over time due to solder build-up and wear

Z - Kelvin

0.40 mm

Z-KELVIN

ECT's ZIP® Kelvin .4mm is ideal for voltage sensitive tests on array or peripheral devices requiring milliohm resistance measurements as well as high-power test applications.

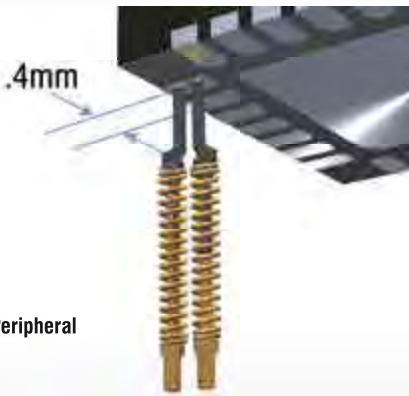

Peripheral



Array

Z-040KHJ

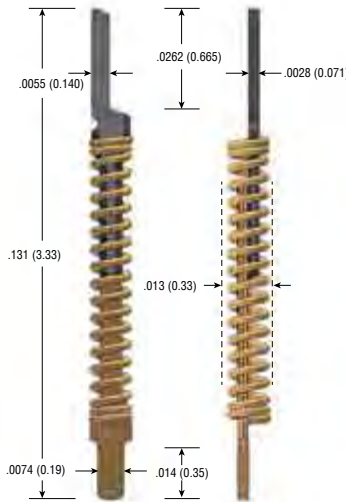

Mechanical

Pitch:	.016 (0.40)
Recommended Travel:	.025 (0.64)
Full Travel:	.028 (0.71)
Test Height:	.105 (2.67)
Mechanical Life*:	500,000 cycles
Operating Temperature:	-55°C to +155°C
Spring Force in oz. (grams):	1.20 (34)

Electrical (Static Conditions)

Current Rating DC:	1.2 amps
Average DC Probe Resistance** :	< 70 mOhms
Self Inductance (Ls):	1.0 nH
Capacitance (Cc):	0.40 pF
Bandwidth @ -1dB:	7.0 GHz

Materials and Finishes

Plunger DUT:	HyperCore™
Plunger HIB:	BeCu with proprietary plating
Spring:	Stainless Steel, Gold plated

Tip Style - DUT

K			
			

Tip Style - HIB

J			
			

HYPERcore™
[base material]

Dimensions in inches (millimeters). Specifications subject to change without notice. Consult factory for other temperature requirements, and applications below -40°C. Stocking Disclaimer: Stocking levels for part numbers listed in this catalog are subject to change. Availability is based on current levels of usage and demand.



ECT CONTACT PRODUCTS
A Cobu Company
ECT-CPG.com
shop.ECT-CPG.com

* Life specifications are based on lab results but are dependent on cleaning frequency and the specific customer application, including DUT materials, handler kit, maintenance, etc.
 ** Contact resistance will increase over time due to solder build-up and wear

BTM

0.50 mm, 0.75 mm, 1.00 mm

BTM-050

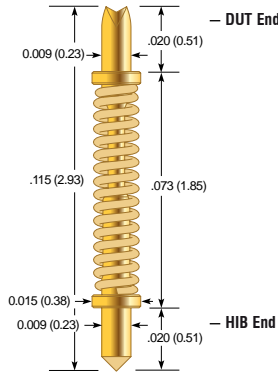

Mechanical

Pitch:	.019 (0.50)
Recommended Travel:	.015 (0.38)
Full Travel:	.020 (0.51)
Test Height:	.098 (2.49)
Mechanical Life*:	500,000 cycles
Operating Temperature:	-55°C to +155°C
Spring Force in oz. (grams):	1.10 (31)

Electrical (Static Conditions)

Current Rating:	2.5 amps
Average DC Probe Resistance**:	<50 mOhms
Self Inductance (Ls):	0.95 nH
Capacitance (Cc):	0.28 pF
Bandwidth @ -1dB:	23.00 GHz

Materials and Finishes

Plunger:	Heat-treated BeCu, Gold plated over hard Nickel or Primeguard 1 for NiPd solder or Primeguard 2 for Lead free solder
Barrel:	Work-hardened BeCu, Gold plated over hard Nickel
Spring:	Steel alloy, Gold plated over hard Nickel

BTM-075

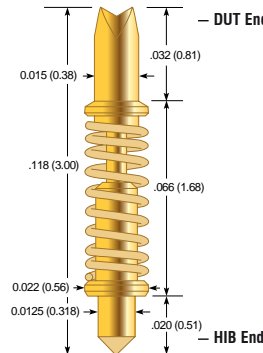

Mechanical

Pitch:	.030 (0.75)
Recommended Travel:	.015 (0.38)
Full Travel:	.020 (0.51)
Test Height:	.103 (2.62)
Mechanical Life*:	500,000 cycles
Operating Temperature:	-55°C to +155°C
Spring Force in oz. (grams):	1.00 (28)

Electrical (Static Conditions)

Current Rating:	2.9 amps
Average DC Probe Resistance**:	<50 mOhms
Self Inductance (Ls):	0.77 nH
Capacitance (Cc):	0.25 pF
Bandwidth @ -1dB:	15.84 GHz

Materials and Finishes

Plunger:	Heat-treated BeCu, Gold plated over hard Nickel or Primeguard 1 for NiPd solder or Primeguard 2 for Lead free solder
Barrel:	Work-hardened Brass, Gold plated over hard Nickel
Spring:	Steel alloy, Gold plated over hard Nickel

BTM-100

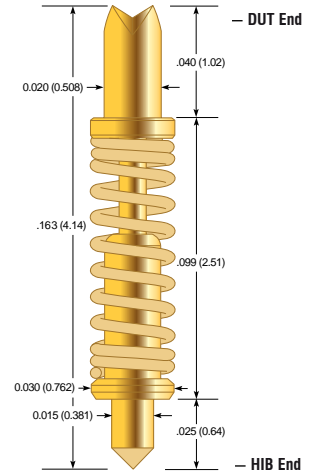

Mechanical

Pitch:	.040 (1.00)
Recommended Travel:	.028 (0.71)
Full Travel:	.030 (0.76)
Test Height:	.136 (3.45)
Mechanical Life*:	500,000 cycles
Operating Temperature:	-55°C to +155°C
Spring Force in oz. (grams):	1.40 (39)

Electrical (Static Conditions)

Current Rating:	3.5 amps
Average DC Probe Resistance**:	<50 mOhms
Self Inductance (Ls):	1.30 nH
Capacitance (Cc):	0.34 pF
Bandwidth @ -1dB:	10.00 GHz

Materials and Finishes

Plunger:	Heat-treated BeCu, Gold plated over hard Nickel or Primeguard 1 for NiPd solder or Primeguard 2 for Lead free solder
Barrel:	Work-hardened Brass, Gold plated over hard Nickel
Spring:	Steel alloy, Gold plated over hard Nickel

Tip Style - DUT



Tip Style - HIB



Tip Style - DUT



Tip Style - HIB



Tip Style - DUT

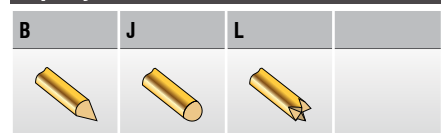

Tip Style - HIB

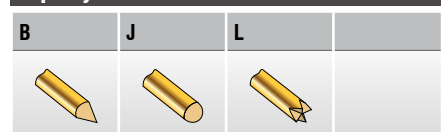

CSP4 0.40 mm

Socket Design Considerations

- CSP series is captured between the socket body and retainer plate, with the barrel fixed in place.
- SCP Socket series is captured between the socket body and retainer plate, with the barrel sliding freely counter bore.
- Counter bore should not be too deep, and enable a minimum amount of preload against interface board.
- Body height and device cavity should be designed to prevent probe from being compressed shorter than test height.

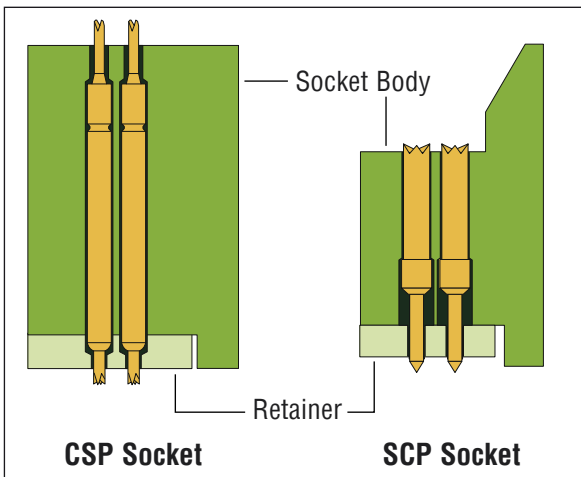

Tip Style - DUT / HIB

B	L		

CSP4-17

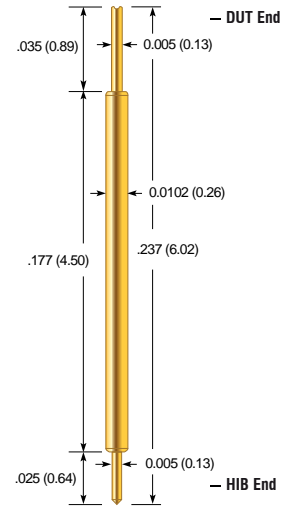

Mechanical

Pitch:	.016 (0.40)
Recommended Travel:	.020 (0.51)
Full Travel:	.025 (0.64)
Test Height:	.217 (5.51)
Mechanical Life*:	250,000 cycles
Operating Temperature:	-55°C to +105°C
Spring Force in oz. (grams):	0.85 (24)

Electrical (Static Conditions)

Current Rating:	2.0 amps
Average DC Probe Resistance**:	< 100 mOhms
Self Inductance (Ls):	1.71 nH
Capacitance (Cc):	0.58 pF
Bandwidth @ -1dB:	6.8 GHz

Materials and Finishes

Plunger DUT:	Heat-treated Steel, Gold plated over hard Nickel
Plunger HIB:	Heat-treated Steel, Gold plated over hard Nickel
Barrel:	Work-hardened Phosphorous Bronze, Gold plated over hard Nickel
Spring:	Music Wire, Gold plated



S= STEEL

* Life specifications are based on lab results but are dependent on cleaning frequency and the specific customer application, including DUT materials, handler kit, maintenance, etc.
** Contact resistance will increase over time due to solder build-up and wear

CSP5

0.50 mm

CSP5-18

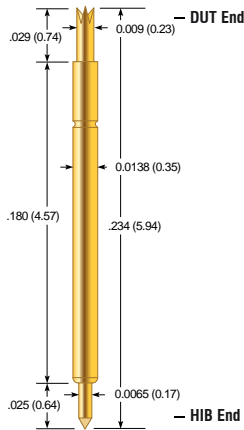

Mechanical

Pitch:	.019 (0.50)
Recommended Travel:	.020 (0.51)
Full Travel:	.025 (0.64)
Test Height:	.214 (5.44)
Mechanical Life*:	500,000 cycles
Operating Temperature:	-55°C to +155°C
Spring Force in oz. (grams):	0.7 (19.8)

Electrical (Static Conditions)

Current Rating:	2 amps
Average DC Probe Resistance**:	<150 mOhms
Self Inductance (Ls):	1.5 nH
Capacitance (Cc):	0.63 pF
Bandwidth @ -1dB:	8.13 GHz

Materials and Finishes

Plunger DUT:	Heat-treated BeCu or Steel, Gold plated over hard Nickel or Primeguard 1 for NiPd solder or Primeguard 2 for Lead free solder
Plunger HIB:	Heat-treated BeCu or Steel, Hard Gold over Nickel
Barrel:	Work-hardened Phosphor Bronze, Gold plated over hard Nickel
Spring:	Steel alloy, Gold plated

CSP5-20

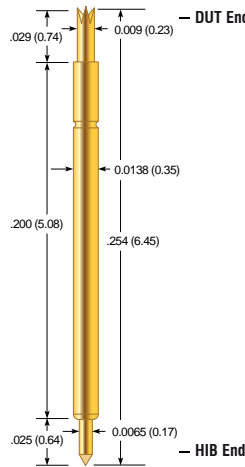

Mechanical

Pitch:	.019 (0.50)
Recommended Travel:	.020 (0.51)
Full Travel:	.025 (0.64)
Test Height:	.234 (5.94)
Mechanical Life*:	500,000 cycles
Operating Temperature:	-55°C to +155°C
Spring Force in oz. (grams):	0.7 (19.8)

Electrical (Static Conditions)

Current Rating:	2 amps
Average DC Probe Resistance**:	<150 mOhms
Self Inductance (Ls):	1.65 nH
Capacitance (Cc):	0.69 pF
Bandwidth @ -1dB:	7.4 GHz

Materials and Finishes

Plunger DUT:	Heat-treated BeCu or Steel, Gold plated over hard Nickel or Primeguard 1 for NiPd solder or Primeguard 2 for Lead free solder
Plunger HIB:	Heat-treated BeCu or Steel, Hard Gold over Nickel
Barrel:	Work-hardened Phosphor Bronze, Gold plated over hard Nickel
Spring:	Steel alloy, Gold plated

CSP5-22

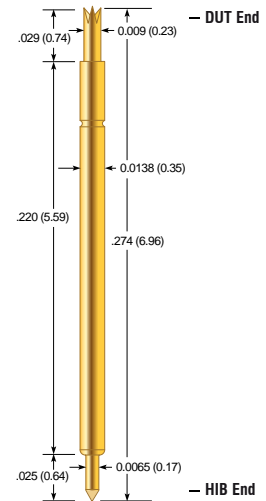

Mechanical

Pitch:	.019 (0.50)
Recommended Travel:	.020 (0.51)
Full Travel:	.030 (0.76)
Test Height:	.254 (6.45)
Mechanical Life*:	500,000 cycles
Operating Temperature:	-55°C to +155°C
Spring Force in oz. (grams):	1.2 (34.9)

Electrical (Static Conditions)

Current Rating:	2 amps
Average DC Probe Resistance**:	<150 mOhms
Self Inductance (Ls):	1.79 nH
Capacitance (Cc):	0.75 pF
Bandwidth @ -1dB:	6.8 GHz

Materials and Finishes

Plunger DUT:	Heat-treated BeCu or Steel, Gold plated over hard Nickel or Primeguard 1 for NiPd solder or Primeguard 2 for Lead free solder
Plunger HIB:	Heat-treated BeCu or Steel, Hard Gold over Nickel
Barrel:	Work-hardened Phosphor Bronze, Gold plated over hard Nickel
Spring:	Steel alloy, Gold plated

Tip Style - DUT / HIB

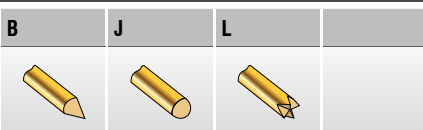

Tip Style - DUT / HIB

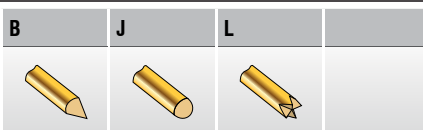

Tip Style - DUT / HIB

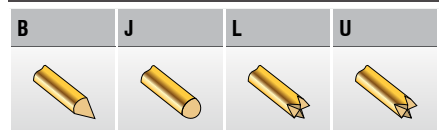

* Life specifications are based on lab results but are dependent on cleaning frequency and the specific customer application, including DUT materials, handler kit, maintenance, etc.
** Contact resistance will increase over time due to solder build-up and wear

CSP8-15

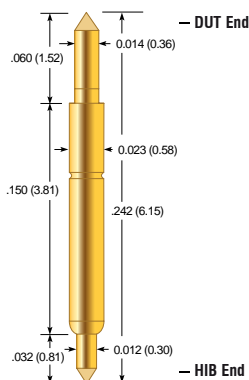

Mechanical

Pitch:	.032 (0.80)
Recommended Travel:	.030 (0.76)
Full Travel:	.034 (0.86)
Test Height:	.212 (5.38)
Mechanical Life*:	500,000 cycles
Operating Temperature:	-55°C to +155°C
Spring Force in oz. (grams):	1.0 (28.3)

Electrical (Static Conditions)

Current Rating:	3 amps
Average DC Probe Resistance**:	<150 mOhms
Self Inductance (Ls):	1.23 nH
Capacitance (Cc):	0.65 pF
Bandwidth @ -1dB:	9.23 GHz

Materials and Finishes

Plunger DUT:	Heat-treated BeCu or Steel, Gold plated over hard Nickel or Primeguard 1 for NiPd solder or Primeguard 2 for Lead free solder
Plunger HIB:	Heat-treated BeCu or Steel, Hard Gold over Nickel
Barrel:	Work-hardened Phosphor Bronze, Gold plated over hard Nickel
Spring:	Steel alloy, Gold plated

CSP8-20

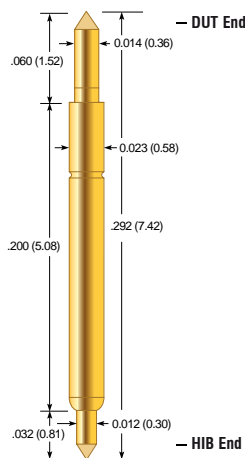

Mechanical

Pitch:	.032 (0.80)
Recommended Travel:	.030 (0.76)
Full Travel:	.035 (0.89)
Test Height:	.262 (6.65)
Mechanical Life*:	500,000 cycles
Operating Temperature:	-55°C to +155°C
Spring Force in oz. (grams):	1.0 (28.3)

Electrical (Static Conditions)

Current Rating:	3 amps
Average DC Probe Resistance**:	<150 mOhms
Self Inductance (Ls):	1.52 nH
Capacitance (Cc):	0.81 pF
Bandwidth @ -1dB:	7.45 GHz

Materials and Finishes

Plunger DUT:	Heat-treated BeCu or Steel, Gold plated over hard Nickel or Primeguard 1 for NiPd solder or Primeguard 2 for Lead free solder
Plunger HIB:	Heat-treated BeCu or Steel, Hard Gold over Nickel
Barrel:	Work-hardened Phosphor Bronze, Gold plated over hard Nickel
Spring:	Steel alloy, Gold plated

CSP8-25

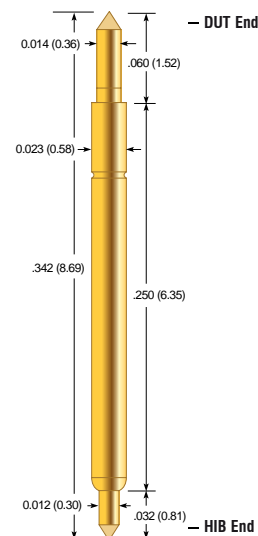

Mechanical

Pitch:	.032 (0.80)
Recommended Travel:	.030 (0.76)
Full Travel:	.040 (1.02)
Test Height:	.312 (7.92)
Mechanical Life*:	500,000 cycles
Operating Temperature:	-55°C to +155°C
Spring Force in oz. (grams):	1.1 (31.2)

Electrical (Static Conditions)

Current Rating:	3 amps
Average DC Probe Resistance**:	<150 mOhms
Self Inductance (Ls):	1.81 nH
Capacitance (Cc):	0.96 pF
Bandwidth @ -1dB:	5.25 GHz

Materials and Finishes

Plunger DUT:	Heat-treated BeCu or Steel, Gold plated over hard Nickel or Primeguard 1 for NiPd solder or Primeguard 2 for Lead free solder
Plunger HIB:	Heat-treated BeCu or Steel, Hard Gold over Nickel
Barrel:	Work-hardened Phosphor Bronze, Gold plated over hard Nickel
Spring:	Steel alloy, Gold plated

Tip Style - DUT / HIB

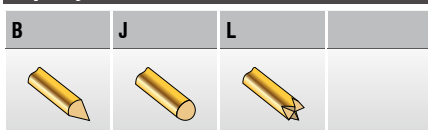

Tip Style - DUT / HIB

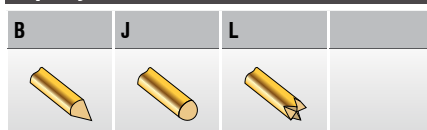

Tip Style - DUT / HIB

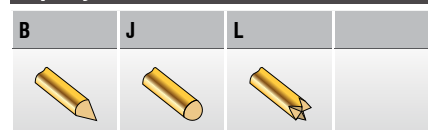

Dimensions in inches (millimeters). Specifications subject to change without notice. Consult factory for other temperature requirements, and applications below -40°C. Stocking Disclaimer: Stocking levels for part numbers listed in this catalog are subject to change. Availability is based on current levels of usage and demand.



* Life specifications are based on lab results but are dependent on cleaning frequency and the specific customer application, including DUT materials, handler kit, maintenance, etc.
** Contact resistance will increase over time due to solder build-up and wear

CSP1

1.0 mm

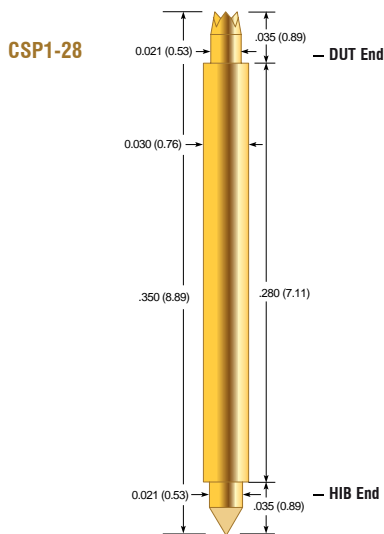

Mechanical

Pitch:	.039 (1.0)
Recommended Travel:	.030 (0.76)
Full Travel:	.040 (1.02)
Test Height:	.315 (8.00)
Mechanical Life*:	500,000 cycles
Operating Temperature:	-55°C to +155°C
Spring Force in oz. (grams):	2.0 (57)

Electrical (Static Conditions)

Current Rating:	3 amps
Average DC Probe Resistance**:	< 100 mOhms
Self Inductance (Ls):	3.10 nH
Capacitance (Cc):	0.95 pF
Bandwidth @ -1dB:	3.80 GHz

Materials and Finishes

Plunger DUT:	Heat-treated BeCu, Gold plated over hard Nickel
Plunger HIB:	Heat-treated BeCu, Gold plated over hard Nickel
Barrel:	Work-hardened Phosphor Bronze, Gold plated over hard Nickel
Spring:	Steel alloy, Gold plated

Tip Style - DUT / HIB

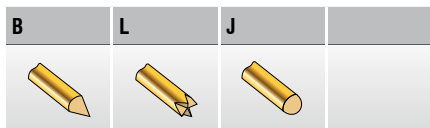

ORDER KEY

BTM-050 / 075 / 100

Series	Size	DUT Tip Style	HIB Tip Style	Plating Type
BTM	050	L	J	-2
BTM	075	B	J	-1
BTM	100	L	J	-1

Blank = Gold
 -1 = Primeguard 1
 -2 = Primeguard 2

CSP-1

Series	Size	DUT Tip Style	DUT Material	HIB Tip Style	HIB Material
CSP1	28	L	C	B	C

CSP5 / CSP8

Series	Size	DUT Tip Style	DUT Material	HIB Tip Style	HIB Material	Plating
CSP5	22	L	C	L	S	1
CSP5	22	L	S	J	S	2
CSP8	25	L	S	J	S	

SCP-080 / 100 / 127

Series	Size	DUT Tip Style	HIB Tip Style
SCP	080	Z	J
SCP	100	Z	J
SCP	127	Z	J

* Life specifications are based on lab results but are dependent on cleaning frequency and the specific customer application, including DUT materials, handler kit, maintenance, etc.
 ** Contact resistance will increase over time due to solder build-up and wear



SCP

0.80 mm, 1.00 mm, 1.27 mm

SCP-080

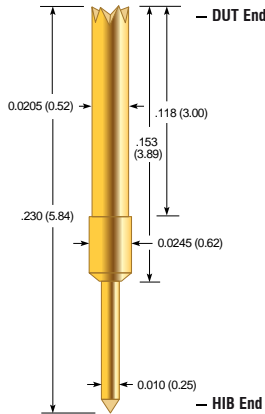

Mechanical

Pitch:	.032 (0.80)
Recommended Travel:	.030 (0.76)
Full Travel:	.035 (0.89)
Test Height:	.200 (5.08)
Mechanical Life*:	1,000,000 cycles
Operating Temperature:	-55°C to +155°C
Spring Force in oz. (grams):	1.50 (42.5)

Electrical (Static Conditions)

Current Rating:	5 amps
Average DC Probe Resistance**:	<50 mOhms
Self Inductance (Ls):	1.27 nH
Capacitance (Cc):	0.12 pF
Bandwidth @ -1dB:	6.0 GHz

Materials and Finishes

Plunger:	Heat-treated BeCu, Gold plated over hard Nickel
Barrel:	Work-hardened BeCu, Gold plated over hard Nickel
Spring:	Steel alloy, Gold plated

Tip Style - DUT

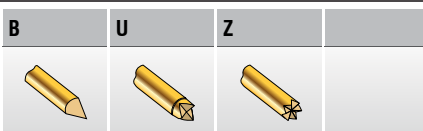

Tip Style - HIB

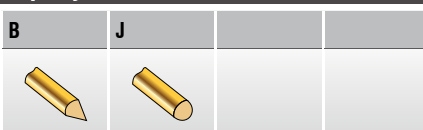

SCP-100

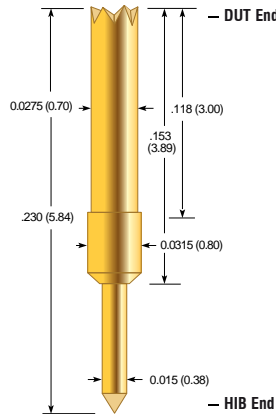

Mechanical

Pitch:	.039 (1.00)
Recommended Travel:	.030 (0.76)
Full Travel:	.035 (0.89)
Test Height:	.200 (5.08)
Mechanical Life*:	1,000,000 cycles
Operating Temperature:	-55°C to +155°C
Spring Force in oz. (grams):	1.50 (42.5)

Electrical (Static Conditions)

Current Rating:	7 amps
Average DC Probe Resistance**:	<50 mOhms
Self Inductance (Ls):	1.40 nH
Capacitance (Cc):	0.66 pF
Bandwidth @ -1dB:	6.70 GHz

Materials and Finishes

Plunger:	Heat-treated BeCu, Gold plated over hard Nickel
Barrel:	Work-hardened BeCu, Gold plated over hard Nickel
Spring:	Steel alloy, Gold plated

Tip Style - DUT

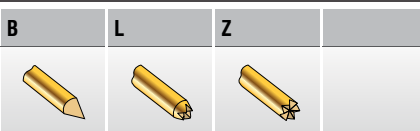

Tip Style - HIB

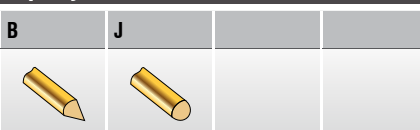

SCP-127

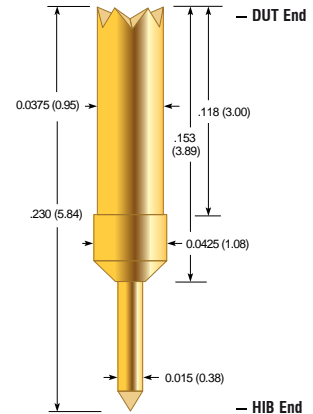

Mechanical

Pitch:	.050 (1.27)
Recommended Travel:	.030 (0.76)
Full Travel:	.035 (0.89)
Test Height:	.200 (5.08)
Mechanical Life*:	1,000,000 cycles
Operating Temperature:	-55°C to +155°C
Spring Force in oz. (grams):	1.50 (42.5)

Electrical (Static Conditions)

Current Rating:	9 amps
Average DC Probe Resistance**:	<50 mOhms
Self Inductance (Ls):	1.40 nH
Capacitance (Cc):	0.79 pF
Bandwidth @ -1dB:	7.6 GHz

Materials and Finishes

Plunger:	Heat-treated BeCu, Gold plated over hard Nickel
Barrel:	Work-hardened BeCu, Gold plated over hard Nickel
Spring:	Steel alloy, Gold plated

Tip Style - DUT

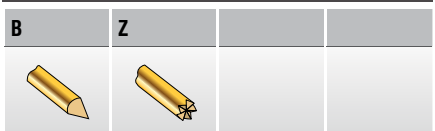

Tip Style - HIB

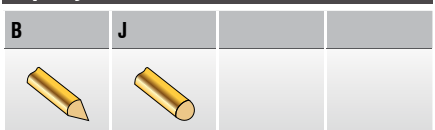

Dimensions in inches (millimeters). Specifications subject to change without notice. Consult factory for other temperature requirements, and applications below -40°C. Stocking Disclaimer: Stocking levels for part numbers listed in this catalog are subject to change. Availability is based on current levels of usage and demand.



* Life specifications are based on lab results but are dependent on cleaning frequency and the specific customer application, including DUT materials, handler kit, maintenance, etc.
** Contact resistance will increase over time due to solder build-up and wear

TOOLS AND MAINTENANCE

ECT Probes *love* ECT Tools

On the following pages, we offer a variety of tools to insert or extract probes and receptacles. These tools are made from durable steel and other materials to ensure a long life.

You will also find probe handling and maintenance instructions to help maximize the life of our products.

PROBE HANDLING INSTRUCTIONS

Special care should be used when handling some small diameter probes such as the POGO-72. Their long length makes them more susceptible to bending than their 100 mil counterparts. It is recommended that the plunger not be deflected unless it is in its mating receptacle, which should be installed in a probe plate. If deflection is required prior to insertion into the mating receptacle, please follow these guidelines to reduce the possibility of damage.

- 1) Hold the top of the probe barrel firmly between the forefinger and thumb of one hand.
- 2) Using the forefinger of the opposite hand (or a wooden dowel if it is a pointed tip), deflect the plunger the required distance.



Correct



Incorrect

BOARD MARKER TOOLS

Part No.	Description	Used on
RIT-BMP	Receptacle insertion tool	BMR-1
EXT-BMP	BMP insertion/extraction tool	BMP-1/BMP-3



POGO® MAINTENANCE

Generally, Pogo cleaning is not recommended. However, in some cases electrical conductivity can be improved if the spring probe tips are cleaned of any contaminants. Contaminants can form an insulation barrier on the probe tip, thus reducing contact integrity.

One of the most widely used methods for cleaning spring contact probes involves the use of brushes to clean the probe heads without probe removal from the test fixture. This technique allows for more frequent maintenance resulting in improved fixture reliability. After brushing contaminants free from the probes, the fixture should be vacuumed to ensure remaining particles do not create future problems.

Another cleaning method involves removal of probes from the test fixture, bundling them together, and submerging the probe tips in a shallow pan of safe solution such as alcohol or citric cleaner for five minutes. After soaking, the probe tips can be scrubbed with a soft bristle brush to remove any residue, then rinsed and dried. The probes can then be reinstalled in the test fixture. This method should be attempted only as a last resort, as cleaning fluids and solvents can wash contaminants into the probes as well as the fixture.

Maintenance Tools

Part No. ECT	Part No. OB	Description	Dimensions
MPB-01	MB-1	Brass bristle brush	4.25 x 2.50 (108 x 64)
MPB-02	MB-2	4 row brass brush	3.25 x 1.125 (83 x 29)
MPB-03	MB-3	Nylon brush	6.25 (159)

Dimensions in inches (millimeters). Specifications subject to change without notice. Consult factory for other temperature requirements, and applications below -40°C. Stocking Disclaimer: Stocking levels for part numbers listed in this catalog are subject to change. Availability is based on current levels of usage and demand.

GENERAL PURPOSE-REPLACEABLE INSERTION TOOLS

Made from the highest quality stainless steel, these durable, corrosion-resistant tools are guaranteed to provide years of service. They are engineered for easy control and to fit comfortably in your hand for ease of use.

For receptacle installation, choose the RIT or ART tool that matches the receptacle and follow the Insertion Instructions. The press ring keeps the receptacle in place, so no glue is required. The spring probe can then be inserted into the receptacle to complete the installation.

The height of the probe can be changed by mounting the receptacle at different heights. For more information on receptacles, refer to the technical section of this catalog.



1. Insert receptacle into the drill hole.



2. Insert tip of RIT tool into the top of the receptacle and, with slight hand pressure, seat the receptacle into the drill hole until resistance is met.



3. Tap the top of the tool with a small plastic hammer until the receptacle is seated at the proper height. The press ring keeps the receptacle in place.

Receptacle Insertion Tools

Part No. ECT	Part No. OB	Mounting Height	Used on ECT	Used on OB
ARIT-1	ARIT40	Flush to .220 (5.59)	SPR-1/LTR-1	SR40/LR40
ARIT-1M	ARIT40M	Flush to .220 (5.59)	SPR-1/LTR-1	SR40/LR40
ARIT-25	ARIT54	Flush to .220 (5.59)	SPR-2/-25/-64	SR54/SR541
ARIT-25M	ARIT54M	Flush to .220 (5.59)	SPR-2/-25/-64	SR54/SR541
ART-62		Flush to .285 (7.24)	HPR-62	
ART-72	AT31	Flush to .220 (5.59)	HPR-72	HPR-72
RIT-0-0	T261-0	Flush	SPR-0	SR261
RIT-1-0		Flush	SPR-1/LTR-1	
RIT-3-0	T80-0	Flush	SPR-3	SR80
RIT-30-0	T20-0	Flush	HPR-30	SR20
RIT-4-0	T93-0	Flush	SPR-4	SR93
RIT-40-0	T27-0	Flush	HPR-40	SR27
RIT-5-0	T125-0	Flush	SPR-5	SR125
RIT-39		Flush	SPR-39	
RIT-64-005	MRT54-005	.005 (0.13)	SPR-64	MR54
RIT-74-005	MRT-554-005	.005 (0.13)	SPR-74	MR554
RIT-80-0		Flush	STT-80	

CRIMP PLIER

ECT crimping pliers make receptacle crimping fast and easy. The standard ratchet-action jaws are individually fitted and inspected to ensure quick insertion and removal of receptacles.

The tool features an internal high-tension coil spring for fatigue-free operation and a lifetime of dependable service. Vinyl cushion grips ensure a firm grip with minimum applied pressure. Instructions are provided with each tool purchased.

The 900 series crimp plier requires a corresponding crimp locator (DCL) in order to function properly. Example: To order a plier to crimp a SPR-1W, specify a 900 plier and a DCL-1 crimp locator. If you already have the 900 plier, order only the DCL for the specific receptacle series you require.

Part No. ECT	Part No. OB
900	Model #900

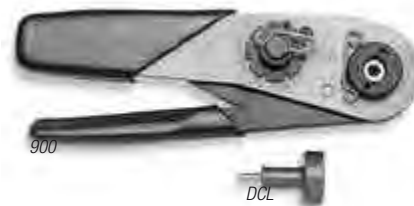

Interchangeable Crimp Plier Locators

Part No. ECT	Part No. OB	Receptacle ECT	Receptacle OB
DCL-0	CL261	SPR-0	SR261
DCL-1	CL40	SPR-1	SR40
DCL-2	CL541	SPR-2	SR541
DCL-3	CL80	SPR-3	SR80
DCL-20		MEP-20	
DCL-25	CL54	SPR-25	SR54
DCL-30	CL20	HPR-30	SR20
DCL-40	CL27	HPR-40	SR27
DCL-62		HPR-62	
DCL-72	CL31	HPR-72	HPR-72



FASTITE® Insertion Instructions

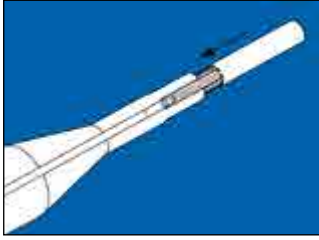

1. Insert insulator, knurled end first into tip of FIT tool



2. Insert prestripped wire into notch on FIT tool and slide until it protrudes approximately 1/8 inch from insulator.



3. Hold wire firmly against tool with forefinger. Insert protruding wire into termination end of W-4 receptacle. Release grasp on wire and push insulator onto end of receptacle, completing termination.



4. Complete termination.

Probe/FASTITE® Insertion Tools

Part No. ECT	Part No. OB	Description	Used on ECT	Used on OB
PIT-0	PIT-261	Probe insertion tool	SPA-0/HPA-0/HPA-50	IP261
PIT-20		Probe insertion tool	MEP-20	
PIE-25	PIE-54	Probe insertion/ extraction tool	All 100mil probes	All 100mil probes
FIT-1	FIT-1	FASTITE® insertion tool	HPR-72W-4/SPR-0W-4 HPR-40T	SR28-4, SR31-4



FIT-1



PIE-25

WIRE WRAPPING TIPS

A wire-wrapped termination is made by coiling the wire around the sharp corners of a .025 (0.64) square receptacle post. By bending the wire around the sharp corner, the oxide layer of both surfaces is broken, revealing an oxide-free surface. This provides clean metal-to-metal contact between the wire and the post. The minimum number of turns is based on wire gauge and the type of wrap. A standard wrap coils only the bare wire around the post. A modified wrap coils the wire and a portion of the insulation. The modified wrap increases the ability to withstand vibration.

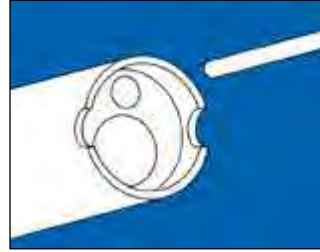

1. Pre-stripped wire, bit and sleeve

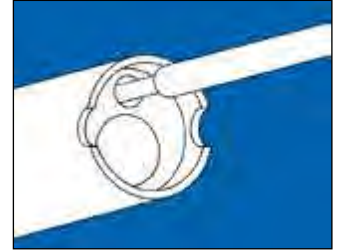

2. Insert wire.



3. Secure wire.

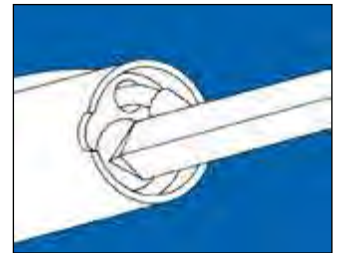

4. Insert terminal, actuate wrapping gun.

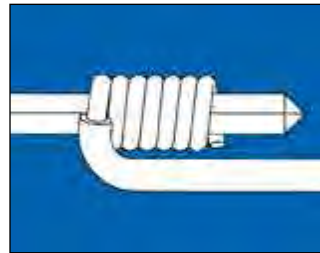

5. Completed termination.

Wire turns per MIL-STD-1130B

(on \square .025 (0.64) WireWrap Post)

Wire Size	Diameter	Minimum Number of Turns	
		Class A (Modified)	Class B (Standard)
30	.010 (0.25)	7 stripped turns plus 1/2 insulated	7 stripped turns
28	.0126 (0.32)	7 stripped turns plus 1/2 insulated	7 stripped turns
26	.0159 (0.40)	6 stripped turns plus 1/2 Insulated	6 stripped turns
24	.0201 (0.51)	5 stripped turns plus 1/2 insulated	5 stripped turns

Dimensions in inches (millimeters). Specifications subject to change without notice.

Consult factory for other temperature requirements, and applications below -40°C.
Stocking Disclaimer: Stocking levels for part numbers listed in this catalog are subject to change.

Availability is based on current levels of usage and demand.

ECT - COMPLIANT CONNECTOR SOLUTIONS



Flexible Solution for your interconnect needs

ECT has developed probe-based Compliant Connector Solutions for the past five decades. Our expanding suite of intellectual property can be easily integrated into your connector solutions. We focus on the most demanding customer applications and support both small and large volume requirements. With a legacy in spring probe and compliant interconnects, ECT is your logical choice for value added connector solutions.

Compliant Connector Advantage

Compliant connectors offer superior durability in high cycle life application compared to leaf spring applications. Pogo based solutions can maintain consistent electro-mechanical characteristics in excess of mission cycles. When mating planar tolerances pose a challenge or a longer reach is required, spring probe based connectors are the preferred solution.

Multi-Phase Project Management

ECT's team will track your project through the following phases.

- Application Discovery
- Solutions Concept
- Design Analysis
- Prototyping
- Production

Architecture

We can support small run custom applications with machined bodies in a variety of materials. For higher volume applications molding structures are available. Connector packaging can be optimized for downstream processes utilizing tape & reel or other techniques.

Standard Connectors

ECT has developed a new standard modular connector to be a high reliability connector for the electrical market. The SC1 connector family features rugged and flexible design attributes, allowing for ease of adaptation to your most challenging applications.

Market Segments Served

Military, aerospace, test & measurement, transportation, industrial and medical are among some of the industries ECT is servicing today. Our experience and understanding of industries' interconnect challenges makes us an ideal connector partner.

Solutions

ECT provides a broad spectrum of products, ranging from rugged high power solution rated at over 75 amps to dense 0.20mm pitch interposers. High reliability solutions for harsh environments, shock resistance, and other stringent specifications are also available.

Applications

Whatever your application requires, ECT has a solution. Battery charger, docking stations, handheld devices, robotic and effectors all benefit from Pogo-based compliant connectors. At the end of the cable or mounted to a circuit board, ECT has your termination.

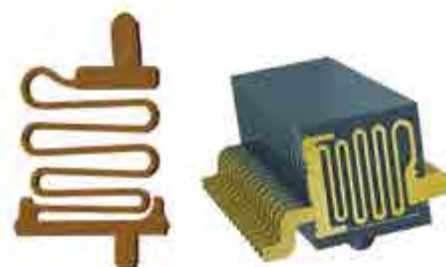

Send special probe request form to
E-Mail: Info.ECT-CPG@Xcerra.com
or Fax: +1-909-574-2909

To	From
Everett Charles Technologies Inc.	Company: _____
14570 Meyer Canyon Drive,	Name: _____
Unit 100	Address: _____
Fontana, CA 92336	_____
Phone: +1 909-625-9390	Phone: _____
E-Mail: Info.ECT-CPG@Xcerra.com	E-Mail: _____

DIMENSIONAL REQUIREMENT

(fill with desired dimensions)

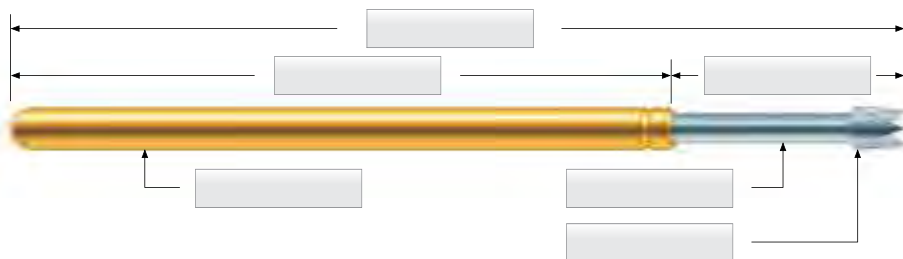

TECHNICAL REQUIREMENTS

Mechanical

Recommended Travel: _____ inch (mm)
 Full Travel: _____ inch (mm)
 Test Center: _____ inch (mm)
 Operating Temperature: _____ °C (min.) _____ °C (max.)

Spring Force

@ Preload: _____ oz. (grams)
 @ Rec. Travel: _____ oz. (grams)

Electrical (Static Conditions)

Current Rating: _____ amps
 Average Probe Resistance: _____ mOhms
 Max. Voltage: _____ V

Plunger Materials and Finishes

Material: BeCu Steel Isolating Other _____
 Finish: Gold LFRE Rhodium Silver Other _____

Description / Comment

TIP REQUIREMENT

Tip Style: _____
 Diameter: _____ inch (mm)

Drawing: _____

ORDER CODE EXAMPLE

ECT

- Series Probe Model number
- Size Probe Size (1-2 digit number)
- Tip Style Tip style (typical a letter)
- Spring Force Spring Force indicated in oz. or sometimes with an order code number indicating standard to ultra-high spring forces.
- Special
 - S Offered on some probes for steel base material
 - SL Offered on the POGO-25I35 Probe for a steel base material and a 2mm longer shaft
 - P indicates the optional anti walkout feature. The probe includes a so called Pylon or Banana Bend



Pylon

- Series Probe Model number
- Plating G Gold Plated Plunger
- Tip Style Tip style (typical a number and a letter)
- Spring Force
 - 1 Standard
 - 2 Alternate
 - 3 Elevated
- Body
 - Pylon Bend Body
 - S Straight Body



Semiconductor Probe - BTM

- Series Probe Model number
- DUT Tip Style Tip style letter
- HIB Tip Style Tip style letter
- Special
 - 1 Primeguard1 plating
 - 2 Primeguard2 plating



Blank = Gold
 -1 = Primeguard 1
 -2 = Primeguard 2

Semiconductor Probe - ZIP

- Series Probe Model number
- Size Pitch
- DUT Tip Style Tip style letter
- DUT Material Plunger base material (ZIP only)
 - H Hypercore
- HIB Tip Style Tip style letter





www.ect-cpg.com



WORLDWIDE OFFICES

America

(1) Everett Charles Technologies Inc.
14570 Meyer Canyon Drive,
Unit 100
Fontana, CA 92336
United States of America
Phone: +1 909-625-9390
E-mail: Info.ECT-CPG@Xcerra.com

(2) ECT Ostby Barton -Pylon
487 Jefferson Blvd.
Warwick, RI 02886
United States of America
Phone: +1 401-739-7310
E-mail: Info.ECT-CPG@Xcerra.com

Asia

(3) 6 Serangoon North Avenue 5
#03-06/07
Singapore-554910
Singapore
Phone: +65 6408 8408
E-mail: Asia.ECT-CPG@Xcerra.com

Europe

(4) Aeussere Oberaustasse 4
83026 Rosenheim
Germany
Phone: +49 (0)8031 40 60
E-mail: Europe.ECT-CPG@Xcerra.com

- Fontana
- Warwick
- Rosenheim
- Singapore

Americas

Brazil
Canada
Mexico
United States of America

Asia

China
Hong Kong
India
Japan
Korea
Malaysia
The Philippines
Singapore
Taiwan
Thailand
Vietnam

Australia

Middle East

Israel

Africa

South Africa
Tunisia

Europe

Austria
Belarus
Belgium
Bulgaria
Croatia
Czech Republic
Denmark
Estonia
Finland
France
Germany
Hungary
Ireland
Israel
Italy
Lithuania
Luxembourg
Montenegro
Netherlands
Poland
Portugal
Romania

Russia
Serbia
Slovakia
Slovenia
Spain
Sweden
Switzerland
Turkey
Ukraine
United Kingdom

Your ECT Contact is: